

# 2012 MLCC PRODUCT GUIDE

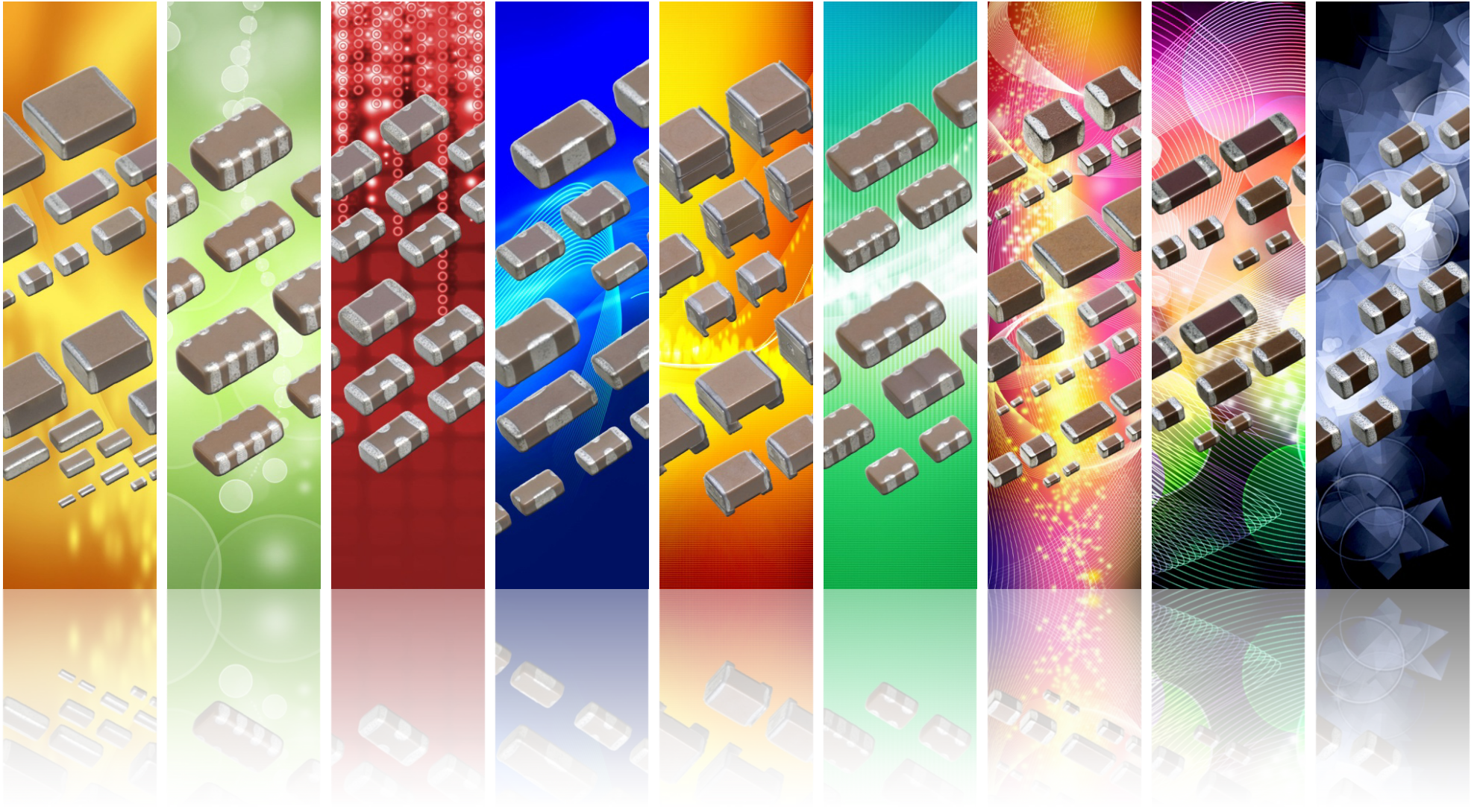

# Message to Customers



This Product Guide is the official TDK multilayer ceramic capacitor product line up for 2012. The purpose of this document is to communicate our MLCC products and services so that you will completely understand the full TDK product offering as well as all available services and resources. A table of contents is provided below to assist you in locating your material of interest. I would also like to point out an exhaustive listing of all new part numbers is provided at the end of the guide. This material is updated semi-annually and further supplemented by the contents on the web page, [www.tdk.com](http://www.tdk.com). I invite you to regularly reference this document and/or [tdk.com](http://tdk.com) for the most current product news, information and resources.

Respectfully,

*Steve Maloy*

Director of MLCC Product Marketing and Development  
[steve.maloy@us.tdk.com](mailto:steve.maloy@us.tdk.com) / 847.390.4377  
[www.tdk.com](http://www.tdk.com)

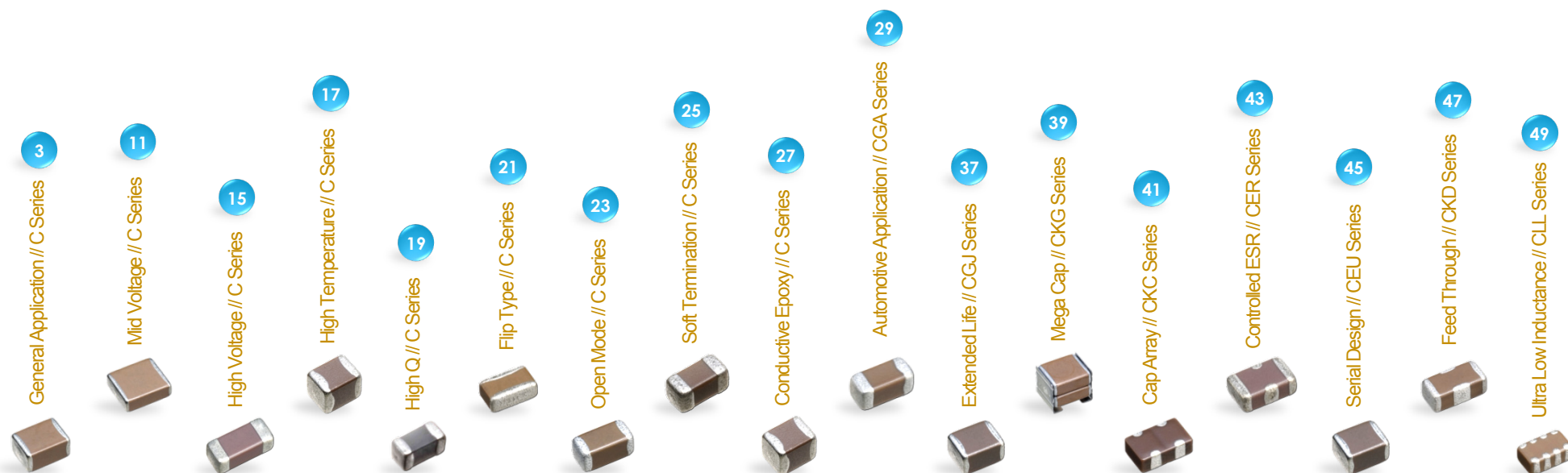



## SERIES

## FEATURES

## OFFERING

C

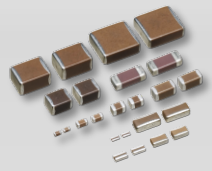

General Application

Mid Voltage

High Voltage

High Temperature

High Q

Flip Type

Open Mode

Soft Termination

Conductive Epoxy

CER

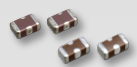

Controlled ESR

CEU



Serial Design

CGA

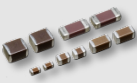

Automotive Application

CGJ



Extended Life

CKC



2-in-1 Array  
4-in-1 Array

CKD



Feed Through

CKG



Mega Cap

CLL



Ultra Low Inductance

- Wide range of case size and superior dimension precision
- Available in EIA class 1 and 2 dielectrics up to 50V
- Unique design allows for higher voltage in smaller case size
- Available in 100V, 250V, 450V, and 630V
- Advance design provides improved withstanding voltage
- Available rating up to 3000V
- Stable temperature characteristics up to 150°C
- Highly precise temperature performance ( $\pm 7.5\%$ ) up to 125°C
- Design with higher Q factor than standard capacitors
- Excellent attenuation and high self resonance frequency (SRF)
- Flipped geometry provides lower inductance than standard capacitor
- Special design allows for adequate high frequency current to IC
- Unique design allows for increase resistance to mechanical bending
- Improved performance in vibration and electrical stresses
- Improved bending resistance and temperature cycle performance
- Termination technology available for most case sizes including arrays
- AgPdCu termination for conductive glue mounting
- Improved mechanical/thermal strength when used with conductive glue
- Unique design allows for specified "controlled" ESR
- Same no-hassle mounting method as standard 2-terminal components
- ESR is controlled without affecting the ESL
- 2 series-connected capacitors in one body
- Improved bending resistance and temperature cycle performance
- Ultra high reliability design for automotive battery line applications
- Qualified to CDF AEC Q-200 automotive testing standard
- Manufactured using matured process for guaranteed performance
- Available in C0G, X7R and X8R temperature characteristics
- Extensive testing to ensure higher reliability and longer life
- Reliability tests based on MIL-STD requirements
- Guaranteed TC Bias and Hot IR performance
- Allows for reduction of PCB space and mounting time
- Unique electrode design reduces crosstalk
- Also available in soft termination for higher reliability performance
- Optimized for noise bypass with signal and power source circuits
- Can be used for meeting EMC requirements
- Ideal for use at higher frequencies due to low parasitic inductance
- Advance design for twice the capacitance on single footprint
- Improved vibration and thermal/mechanical stress performance
- Lower ESR and ESL than ALU and TA capacitor
- Unique internal structure allows cancelation of magnetic fields to reduce equivalent series inductance
- Eight sided terminal electrode design in one capacitor

- 01005 ~ 2220 / C0G, SL, X5R, X6S, X7R, X7S, Y5V
- 4V ~ 50V / up to 100  $\mu$ F
- 0402 ~ 2220 / C0G, X6S, X7R, X7S, X7T
- 100V ~ 630V / up to 15  $\mu$ F
- 1808 ~ 1812 / C0G, X7R, X7S
- 1000V ~ 3000V / up to 10 nF
- 0402 ~ 1210 / X8R
- 16V ~ 100V / up to 10  $\mu$ F
- 0201 / C0G
- 25V / up to 20 pF
- 0204 ~ 0612 / X5R, X6S, X7R, X7S
- 4V ~ 50V / up to 10  $\mu$ F
- 0805 ~ 2220 / X7R, X8R
- 16V ~ 630V / up to 22  $\mu$ F
- 0805 ~ 3025 / X7R, X7S, X7T
- 16V ~ 630V / up to 100  $\mu$ F
- 0402 ~ 1210 / C0G, X7R, X8R
- 25V ~ 100V / up to 10  $\mu$ F
- 0603 ~ 0805 / X5R
- 4V ~ 10V / up to 10  $\mu$ F
- 0603 ~ 0805 / X7R
- 50V / up to 100 nF
- 0402 ~ 2220 / C0G, X5R, X7R, X7S, X7T, X8R
- 6.3V ~ 630V / up to 47  $\mu$ F
- 0402 ~ 1206 / C0G, X7R
- 6.3V ~ 50V / up to 10  $\mu$ F
- CKCN27 ~ CKCA43 / C0G, X5R, X7R
- 6.3V ~ 50V / up to 2.2  $\mu$ F
- 0402 ~ 1206 / up to 125°C temperature range
- 6.3V ~ 50V / up to 22  $\mu$ F
- CKGxxK ~ CKGxxN / X5R, X7R, X7S, X7T
- 16V ~ 630V / up to 100  $\mu$ F
- 0603 ~ 0805 / X7R, X7S
- 4V ~ 10V / up to 4.7  $\mu$ F

# C SERIES | General Application

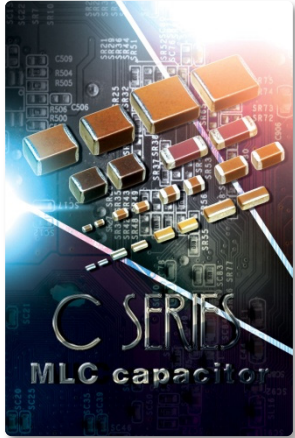

TDK C series offers high capacitance MLCC achieved through precision technologies by enabling the use of multiple thinner ceramic dielectric layers. TDK advanced manufacturing process offers MLCC with monolithic structure and superior mechanical strength as well as a high level of reliability. Composed of only ceramics and base metals, these capacitors provide extremely dependable performance, exhibiting virtually no degradation even when subjected to temperature extremes. Low stray capacitance ensures high conformity with nominal values, thereby simplifying the circuit design process. Owing to their low ESR and excellent frequency characteristics, these products are optimally suited for a variety of application.

Case Code	L (mm)	W (mm)	T max (mm)
C0402/01005	0.40	0.20	0.20
C0603/0201	0.60	0.30	0.30
C1005/0402	1.00	0.50	0.50
C1608/0603	1.60	0.80	0.80
C2012/0805	2.00	1.25	1.25
C3216/1206	3.20	1.60	1.60
C3225/1210	3.20	2.50	2.50
C4532/1810	4.50	3.20	3.20
C5750/2220	5.70	5.00	2.80

L Body Length  
 W Body Width  
 T Body Height  
 B Terminal Width

## Part Number Description

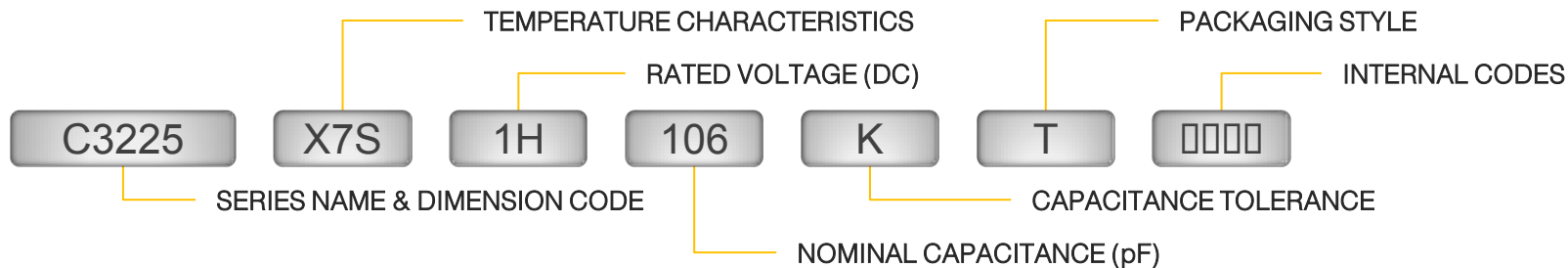

## Features:

- ❖ TDK's proprietary internal electrode structure
- ❖ Wide capacitance range up to 100μF
- ❖ Available voltage rating of 4V to 50V
- ❖ Superior mechanical strength and reliability
- ❖ Low ESR characteristic
- ❖ Easy mounting due to no polarity

## Applications:

- ❖ General electronic equipment
- ❖ Mobile communication equipment
- ❖ Power supply circuit
- ❖ Office automation equipment
- ❖ TV/LED displays
- ❖ Servers/PCs/Notebooks/Tablets
- ❖ Test and measurement equipment
- ❖ Hybrid ICs, etc.
- ❖ Decoupling
- ❖ Smoothing
- ❖ Charge pump

## Basic Design Construction Multi-layer Capacitor

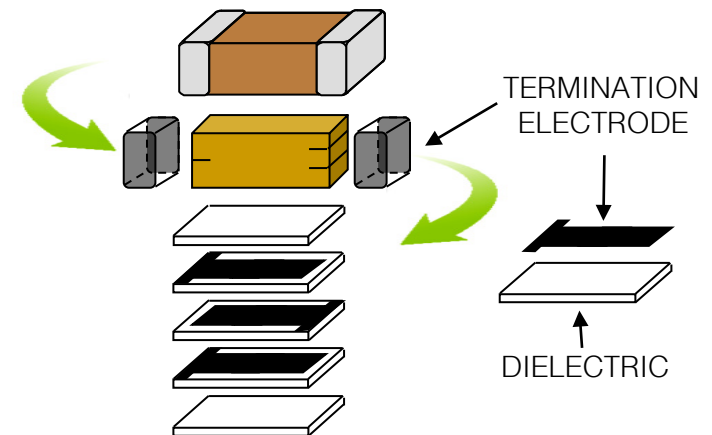



# C SERIES | General Application / C0G, SL

Capacitance (pF)	Cap Code	C0402 01005		C0603 0201		C1005 0402		C1608 0603	
		1C (16V)	1H (50V)	1E (25V)	1H (50V)	1H (50V)			
0.2	0R2	█		█					
0.3	0R3	█		█					
0.4	0R4	█		█					
0.5	0R5	█	█	█	█	█			
0.6	0R6	█		█					
0.7	0R7	█		█					
0.75	R75	█		█					
0.8	0R8	█		█					
0.9	0R9	█		█					
1.0	0I0	█	█	█	█	█			
1.1	1R1	█		█					
1.2	1R2	█		█					
1.3	1R3	█		█					
1.5	1R5	█		█					
1.6	1R6	█		█					
1.8	1R8	█		█					
2.0	020	█		█					
2.2	2R2	█		█					
2.4	2R4	█		█					
2.5	2R5	█		█					
2.7	2R7	█		█					
3.0	030	█		█					
3.3	3R3	█		█					
3.5	3R5	█		█					
3.6	3R6	█		█					
3.9	3R9	█		█					
4.0	040	█		█					
4.3	4R3	█		█					
4.7	4R7	█		█					
5.0	050	█		█					
5.1	5R1	█		█					
5.6	5R6	█		█					
6.0	060	█		█					
6.2	6R2	█		█					
6.8	6R8	█		█					
7.0	070	█		█					
7.5	7R5	█		█					
8.0	080	█		█					
8.2	8R2	█		█					
9.0	090	█		█					
9.1	9R1	█		█					
10	100	█		█					
11	110	█		█					
12	120	█		█					
13	130	█		█					
15	150	█		█					
16	160	█		█					
18	180	█		█					
20	200	█		█					

Capacitance (pF)	Cap Code	C0402 01005		C0603 0201		C1005 0402			C1608 0603		C2012 0805		C3216 1206
		1C (16V)	1H (50V)	1E (25V)	1H (50V)	1E (25V)	1A (10V)	1H (50V)	1E (25V)	1H (50V)	1E (25V)	1H (50V)	
22	220	█	█	█	█				█				
24	240	█	█	█	█				█				
27	270	█	█	█	█				█				
30	330	█	█	█	█				█				
33	330	█	█	█	█				█				
36	360	█	█	█	█				█				
39	390	█	█	█	█				█				
43	430	█	█	█	█				█				
47	470	█	█	█	█				█				
51	510	█	█	█	█				█				
56	560	█	█	█	█				█				
62	620	█	█	█	█				█				
68	680	█	█	█	█				█				
75	750	█	█	█	█				█				
82	820	█	█	█	█				█				
91	910	█	█	█	█				█				
100	101	█	█	█	█				█		█		
110	111	█	█	█	█				█		█		
120	121	█	█	█	█				█		█		
130	131	█	█	█	█				█		█		
150	151	█	█	█	█				█		█		
160	161	█	█	█	█				█		█		
180	181	█	█	█	█				█		█		
200	201	█	█	█	█				█		█		
220	221	█	█	█	█				█		█		
240	24	█	█	█	█				█		█		
270	271	█	█	█	█				█		█		
300	301	█	█	█	█				█		█		
330	331	█	█	█	█				█		█		
360	361	█	█	█	█				█		█		
390	391	█	█	█	█				█		█		
430	431	█	█	█	█				█		█		
470	471	█	█	█	█				█		█		
510	511	█	█	█	█				█		█		
560	561	█	█	█	█				█		█		
620	621	█	█	█	█				█		█		
680	681	█	█	█	█				█		█		
750	751	█	█	█	█				█		█		
820	821	█	█	█	█				█		█		
910	911	█	█	█	█				█		█		
1,000	102	█	█	█	█				█		█		
1,200	122	█	█	█	█				█		█		
1,500	152	█	█	█	█				█		█		
1,800	182	█	█	█	█				█		█		
2,200	222	█	█	█	█				█		█		
2,700	272	█	█	█	█				█		█		
3,300	332	█	█	█	█				█		█		
3,900	392	█	█	█	█				█		█		
4,700	472	█	█	█	█				█		█		

█ C0G █ SL

# C SERIES | General Application / C0G, SL, X5R

Capacitance (pF)	Cap Code	C1608 0603			C2012 0805			C3216 1206			C3225 1210	C4532 1812
		1H (50V)	1E (25V)	1A (10V)	1H (50V)	1E (25V)	1A (10V)	1H (50V)	1E (25V)	1A (10V)	1H (50V)	1H (50V)
5,600	562	■	■		■	■		■				
6,800	682	■			■			■				
8,200	822	■			■			■				
10,000	103	■			■			■				
15,000	153			■	■			■				
22,000	223			■	■			■		■		
33,000	333				■			■			■	
47,000	473							■				■
68,000	683							■			■	
100,000	104							■				■
150,000	154									■		■
220,000	224									■		■

Capacitance (pF)	Cap Code	C0402 01005				C0603 0201						C1005 0402							
		1C (16V)	1A (10V)	0J (6.3V)	0G (4V)	1H (50V)	1E (25V)	1C (16V)	1A (10V)	0J (6.3V)	0G (4V)	1H (50V)	1V (35V)	1E (25V)	1C (16V)	1A (10V)	0J (6.3V)	0G (4V)	
100	101	■	■			■	■												
150	151	■				■													
220	221		■									■							
330	331	■	■			■													
470	471	■	■			■													
1,000	102	■		■		■						■							
1,500	152		■	■								■							
2,200	222		■																
3,300	332			■				■											
4,700	472							■											
6,800	682			■					■										
10,000	103			■					■					■					
15,000	153													■					
22,000	223																		
33,000	333																		
47,000	473																		
68,000	683																		
100,000	104			■	■			■	■			■			■	■	■	■	
150,000	154							■	■			■	■					■	
220,000	224							■	■									■	
330,000	334																		
470,000	474																		
680,000	684																		
1,000,000	105											■							
1,500,000	155																		
2,200,000	225																		
3,300,000	335																		
4,700,000	475																	■	

■ C0G ■ SL ■ X5R

# C SERIES | General Application / X5R

Capacitance (pF)	Cap Code	C1608 0603							C2012 0805						C3216 1206							
		1H (50V)	1V (35V)	1E (25V)	1C (16V)	1A (10V)	0J (6.3V)	0G (4V)	1H (50V)	1E (25V)	1C (16V)	1A (10V)	0J (6.3V)	0G (4V)	1H (50V)	1V (35V)	1E (25V)	1C (16V)	1A (10V)	0J (6.3V)	0G (4V)	
100,000	104	■		■																		
150,000	154			■																		
220,000	224	■		■	■	■																
330,000	334			■	■	■																
470,000	474			■	■	■																
680,000	684	■		■	■	■																
1,000,000	105	■	■	■	■	■			■	■	■	■			■							
1,500,000	155			■	■	■																
2,200,000	225		■	■	■	■				■	■	■										
3,300,000	335			■	■	■							■				■	■	■			
4,700,000	475				■	■				■	■	■			■		■	■	■			
6,800,000	685					■												■	■	■		
10,000,000	106					■	■					■			■		■	■	■	■		
15,000,000	156																	■	■	■	■	
22,000,000	226															■		■	■	■	■	
33,000,000	336																	■	■	■	■	
47,000,000	476																	■	■	■	■	
100,000,000	107																			■	■	■

Capacitance (pF)	Cap Code	C3225 1210					C4532 1812				C5750 2220				
		1H (50V)	1E (25V)	1C (16V)	1A (10V)	0J (6.3V)	1E (25V)	1C (16V)	1A (10V)	0J (6.3V)	1H (50V)	1E (25V)	1C (16V)	1A (10V)	0J (6.3V)
4,700,000	475	■													
10,000,000	106						■				■				
15,000,000	156			■	■		■								
22,000,000	226			■	■	■	■	■			■				
33,000,000	336				■	■		■				■			
47,000,000	476					■			■						
68,000,000	686												■		
100,000,000	107								■	■				■	■

■ X5R



# C SERIES | General Application / X6S

Capacitance (pF)	Cap Code	C0603 0201		C1005 0402						C1608 0603							
		0J (6.3V)	0G (4V)	1H (50V)	1V (35V)	1E (25V)	1C (16V)	1A (10V)	0J (6.3V)	0G (4V)	1H (50V)	1V (35V)	1E (25V)	1C (16V)	1A (10V)	0J (6.3V)	0G (4V)
10,000	103																
22,000	223																
47,000	473																
100,000	104																
220,000	224																
470,000	474																
1,000,000	105																
2,200,000	225																
4,700,000	475																
10,000,000	106																

Capacitance (pF)	Cap Code	C2012 0805						C3216 1206						C3225 1210				
		1H (50V)	1V (35V)	1E (25V)	1C (16V)	1A (10V)	0J (6.3V)	0G (4V)	1H (50V)	1V (35V)	1E (25V)	1C (16V)	1A (10V)	0J (6.3V)	0G (4V)	1H (50V)	0J (6.3V)	0G (4V)
100,000	104																	
220,000	224																	
470,000	474																	
1,000,000	105																	
2,200,000	225																	
4,700,000	475																	
10,000,000	106																	

 X6S

# C SERIES | General Application / X7R, X7S

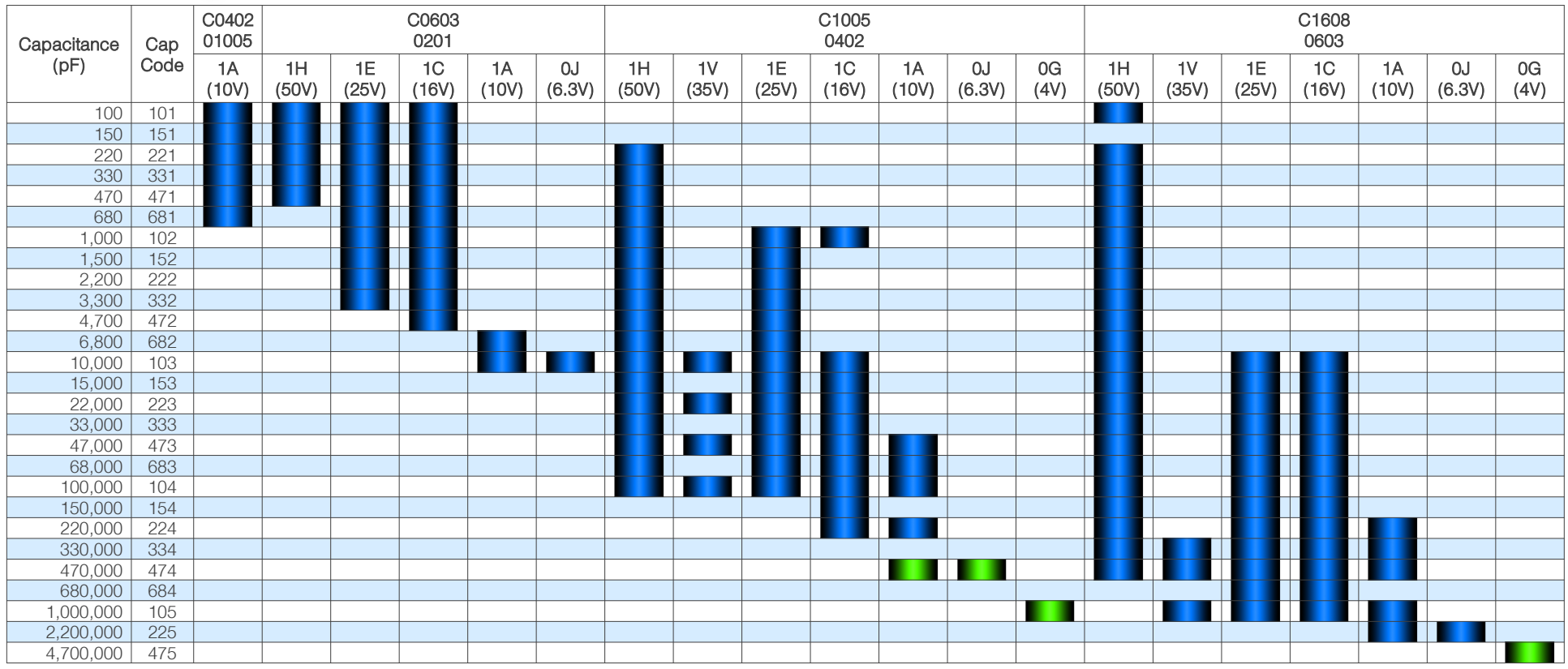

■ X7R    ■ X7S

# C SERIES | General Application / X7R, X7S

Capacitance (pF)	Cap Code	C2012 0805							C3216 1206							C3225 1210			
		1H (50V)	1V (35V)	1E (25V)	1C (16V)	1A (10V)	0J (6.3V)	0G (4V)	1H (50V)	1V (35V)	1E (25V)	1C (16V)	1A (10V)	0J (6.3V)	0G (4V)	1H (50V)	1E (25V)	1C (16V)	1A (10V)
1,000	102	█																	
2,200	222	█																	
4,700	472	█																	
10,000	103	█																	
22,000	223	█																	
47,000	473	█																	
100,000	104	█		█					█										
150,000	154	█		█					█										
220,000	224	█		█	█				█	█									
330,000	334	█		█	█				█	█	█								
470,000	474	█		█	█				█	█	█	█				█			
680,000	684	█		█	█				█	█	█	█				█			
1,000,000	105	█	█	█	█	█			█	█	█	█				█			
1,500,000	155	█		█	█				█	█	█	█				█			
2,200,000	225	█		█	█				█	█	█	█				█	█		
3,300,000	335	█		█	█				█	█	█	█				█			
4,700,000	475	█	█	█	█	█			█	█	█	█				█			
6,800,000	685	█		█	█				█	█	█	█				█			
10,000,000	106	█		█	█		█		█	█	█	█	█		█	█	█		
15,000,000	156	█		█	█				█	█	█	█				█			
22,000,000	226	█		█	█			█					█	█	█			█	█
47,000,000	476	█		█	█			█					█	█	█			█	█

Capacitance (pF)	Cap Code	C4532 1218			C5750 2220		
		1H (50V)	1E (25V)	1C (16V)	1H (50V)	1E (25V)	1C (16V)
1,000,000	105	█					
1,500,000	155	█					
2,200,000	225	█					
3,300,000	335	█					
4,700,000	475	█	█		█		
6,800,000	685	█			█		
10,000,000	106	█			█	█	
15,000,000	156	█			█		
22,000,000	226	█			█		█
33,000,000	336	█			█		
47,000,000	476	█			█		█

█ X7R █ X7S



# C SERIES | General Application / Y5V

Capacitance (pF)	Cap Code	C0603 0201	C1005 0402					C1608 0603					C2012 0805					C3216 1206					
		1C (16V)	1H (50V)	1E (25V)	1C (16V)	1A (10V)	0J (6.3V)	1H (50V)	1E (25V)	1C (16V)	1A (10V)	0J (6.3V)	1H (50V)	1E (25V)	1C (16V)	1A (10V)	0J (6.3V)	1H (50V)	1E (25V)	1C (16V)	1A (10V)	0J (6.3V)	
10,000	103	■	■																				
100,000	104			■	■			■	■	■			■										
220,000	224			■	■	■		■	■														
470,000	474					■		■	■				■										
1,000,000	105						■		■				■	■	■								
2,200,000	225									■	■		■	■	■			■	■				
4,700,000	475											■		■	■	■		■	■	■			
10,000,000	106												■		■	■		■	■	■	■		
22,000,000	226															■		■	■	■	■	■	
47,000,000	476																			■	■	■	■

Capacitance (pF)	Cap Code	C3225 1210					C4532 1812				C5750 2220			
		1H (50V)	1E (25V)	1C (16V)	1A (10V)	0J (6.3V)	1H (50V)	1E (25V)	1C (16V)	1A (10V)	1H (50V)	1E (25V)	1C (16V)	1A (10V)
4,700,000	475	■												
10,000,000	106	■	■	■			■							
22,000,000	226		■	■	■			■			■			
47,000,000	476			■	■				■		■			
100,000,000	107					■				■		■	■	

■ Y5V

# C SERIES | Mid Voltage Capacitor

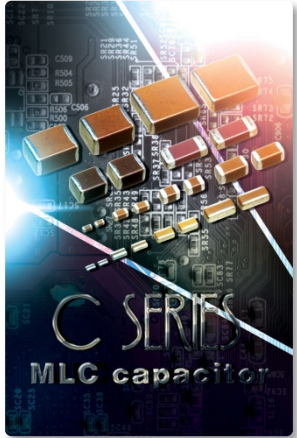

With a rated voltage ranging from 100V to 630V, TDK's mid voltage multilayer ceramic chip capacitors (MLCC) use ceramic dielectric thin-layer and advanced multi-layering technologies to improve capacitance to the industry's highest levels in the mid-voltage range.

These products feature Class I & Class II temperature characteristics (operating temperature range: -55°C and up to 125°C), making them ideal for use in electric flash circuits in digital camera, higher voltage switching power supply smoothing circuits needed for industrial equipment, power factor correction, various lighting application, and general circuits that require higher voltages than traditional sub 100V rated MLCC's.

Case Code	L (mm)	W (mm)	T max (mm)
C1005/0402	1.00	0.50	0.50
C1608/0603	1.60	0.80	0.80
C2012/0805	2.00	1.25	1.25
C3216/1206	3.20	1.60	1.60
C3225/1210	3.20	2.50	2.30
C4532/1810	4.50	3.20	3.20
C5750/2220	5.70	5.00	2.50

L Body Length  
 W Body Width  
 T Body Height  
 B Terminal Width

## Part Number Description

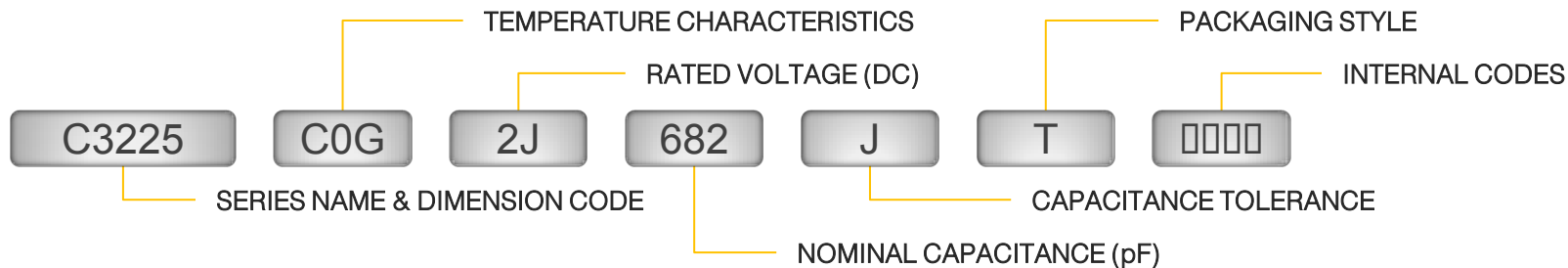

## Features:

- ❖ Advanced dielectric materials
- ❖ Wide capacitance range up to 22uF
- ❖ Higher voltage rating in smaller case size
- ❖ Voltage rating of 100V, 250V, 450V, and 630V
- ❖ High mechanical strength
- ❖ Excellent DC bias properties

## Applications:

- ❖ Snubber in power supply
- ❖ Ringer cap in telephone set and modem
- ❖ Electric flash circuits in digital still camera
- ❖ Power factor correction
- ❖ Input/output filter in power supply
- ❖ Driver circuit in plasma display
- ❖ Noise bypass
- ❖ Lighting application

# C SERIES | Mid Voltage / COG

Capacitance (pF)	Cap Code	C1608 0603		C2012 0805		C3216 1206			C3225 1210			C4532 1812		
		2E (250V)	2A (100V)	2E (250V)	2A (100V)	2J (630V)	2E (250V)	2A (100V)	2J (630V)	2E (250V)	2A (100V)	2J (630V)	2E (250V)	2A (100V)
100	101	COG	COG	COG	COG	COG								
120	121													
150	151													
180	181													
220	221				COG									
270	271													
330	331													
390	391				COG									
470	471				COG									
560	561													
680	681	COG												
820	821			COG										
1,000	102		COG	COG	COG	COG								
1,200	122													
1,500	152													
1,800	182													
2,200	222													
2,700	272													
3,300	332													
3,900	392													
4,700	472				COG									
5,600	562													
6,800	682													
8,200	822													
10,000	103													
15,000	153													
22,000	223													
33,000	333													
47,000	473													
68,000	683													
100,000	104													COG

 COG



# C SERIES | Mid Voltage / X7R, X7S, X7T

Capacitance (pF)	Cap Code	C1005 0402	C1608 0603	C2012 0805			C3216 1206			
		2A (100V)	2A (100V)	2W (450V)	2E (250V)	2A (100V)	2J (630V)	2W (450V)	2E (250V)	2A (100V)
1,000	102	█	█		█	█	█			
1,500	152									
2,200	222	█								
3,300	332	█								
4,700	472									
6,800	682	█								
10,000	103			█	█		█			
15,000	153			█	█				█	
22,000	223									
33,000	333		█	█	█				█	
47,000	473		█	█	█		█			█
68,000	683				█			█	█	
100,000	104		█		█			█		█
150,000	154								█	
220,000	224									
330,000	334									
470,000	474									
1,000,000	105					█				█
2,200,000	225									█

█ X7R   
 █ X7S   
 █ X7T

# C SERIES | Mid Voltage / X7R, X7S, X7T, X6S

Capacitance (pF)	Cap Code	C3225 1210				C4532 1812				C5750 2220			
		2J (630V)	2W (450V)	2E (250V)	2A (100V)	2J (630V)	2W (450V)	2E (250V)	2A (100V)	2J (630V)	2W (450V)	2E (250V)	2A (100V)
47,000	473	■				■							
68,000	683	■				■							
100,000	104	■		■		■							
150,000	154	■		■		■			■				
220,000	224		■	■		■			■				
330,000	334			■	■		■		■			■	
470,000	474				■		■		■		■		■
680,000	684				■					■	■		■
1,000,000	105				■					■	■		■
1,500,000	155										■		■
2,200,000	225				■						■	■	■
3,300,000	335				■								■
4,700,000	475				■				■				■
10,000,000	106												■
15,000,000	156												■

■ X6S   ■ X7R   ■ X7S   ■ X7T

# C SERIES | High Voltage Capacitor

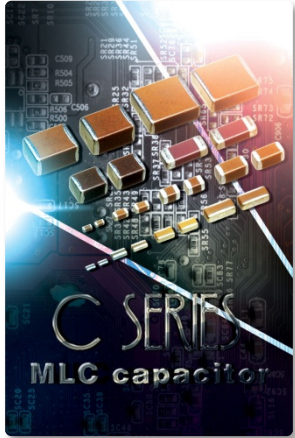

With rated voltage range of 1000V to 3000V, TDK's High Voltage C Series multilayer ceramic chip capacitors (MLCC) use advanced ceramic dielectric thin-layer and multi-layering technologies to offer capacitance to the industry's highest levels in the high-voltage range and improved withstanding voltage characteristics.

These products feature C0G and X7R temperature characteristics (operating temperature range: -55°C to 125°C), making them ideal for use in higher temperature circuit requirements. TDK High Voltage C series is available in 1206 to 2220 case size. Additionally, TDK High Voltage MLCC's feature substantial AC and DC breakdown voltage capabilities to ensure excellent reliability in the higher voltage applications.

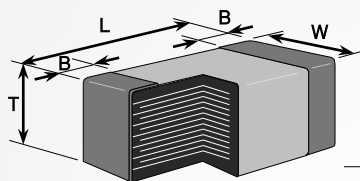

Case Code	Dielectric	L (mm)	W (mm)	T max (mm)
C3216/1206	X7S	3.20	1.60	1.30
C3225/1210	X7S	3.20	2.50	2.50
C4520/1808	C0G	4.50	2.00	2.00
	X7R	4.50	2.00	1.30
C4532/1810	C0G	4.50	3.20	2.50
	X7R	4.50	3.20	2.00
C5750/2220	X7S	5.70	5.00	2.50

L Body Length  
 W Body Width  
 T Body Height  
 B Terminal Width

## Part Number Description

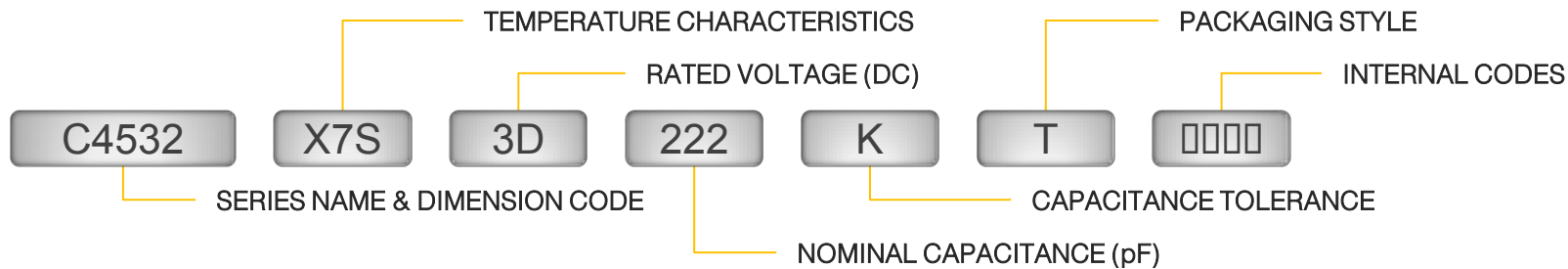

## Features:

- ❖ Up to 3000V rated voltage
- ❖ Wide case size offering 1206 to 2220
- ❖ Advanced design provides improved withstanding voltage characteristics
- ❖ TDK's proprietary internal electrode structure
- ❖ Low ESR at high frequency
- ❖ Low dielectric constant
- ❖ Complies with ISO-8802-3 required for LAN
- ❖ Suitable for 100 Base-T corresponding LAN applications

## Applications:

- ❖ Inverter circuits with a liquid crystal backlight
- ❖ LAN products
- ❖ High voltage coupling
- ❖ Lighting Ballast
- ❖ Higher power DC-DC /AC-DC converter
- ❖ Ethernet Switch
- ❖ Switched mode power supply
- ❖ General high voltage circuits



# C SERIES | High Voltage / C0G, X7R, X7S

Capacitance (pF)	Cap Code	C4520 1808	C4532 1812
		3F (3KV)	3F (3KV)
10	100	█	
12	120	█	
15	150	█	
18	180	█	
22	220	█	
27	270	█	
33	330	█	
39	390	█	
47	470	█	
56	560	█	
68	680	█	
82	820	█	
100	101	█	█
120	121		█
150	151		█
180	181		█
220	221		█
270	271		█
330	331		█

Capacitance (pF)	Cap Code	C3216 1206		C3225 1210		C4520 1808		C4532 1812		C5750 2220	
		3D (2KV)	3A (1KV)	3D (2KV)	3A (1KV)	3D (2KV)	3A (1KV)	3D (2KV)	3A (1KV)	3D (2KV)	3A (1KV)
100	101	█									
220	121										
470	471	█		█		█	█				
1,000	102		█	█				█	█		
2,200	222		█								
4,700	472			█					█	█	
10,000	103								█	█	
22,000	223										█
47,000	473										█

█ X7R █ X7S █ C0G

# C SERIES | High Temperature Capacitor

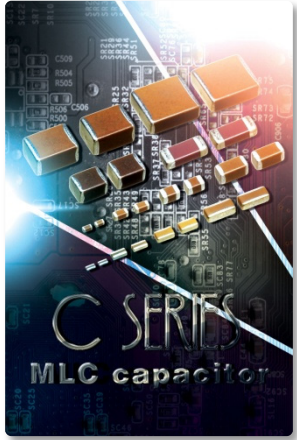

TDK X8R High Temperature Series features stable temperature characteristics and higher reliability performance up to 150°C. This series is designed to meet the needs of automotive applications and/or applications which require operating conditions beyond 125°C of X7R temperature characteristics.

Temperature characteristics of capacitance for this series is stable ( $\pm 15\%$ ) even at the higher temperature ( $\sim 150^\circ\text{C}$ ). Temperature characteristics of capacitance shows highly precise performance (capacitance change of  $\pm 7.5\%$ ) up to 125°C. With precise temperature characteristics, these capacitor are ideal for various high temperature applications such as solar panel inverters, measurement instruments used in high temperature environments as well as smart meter/smart grid application where extreme temperatures are common.

Case Code	L (mm)	W (mm)	T max (mm)
C1005/0402	1.00	0.50	0.50
C1608/0603	1.60	0.80	0.80
C2012/0805	2.00	1.25	1.25
C3216/1206	3.20	1.60	1.60
C3225/1210	3.20	2.50	2.50

## Part Number Description

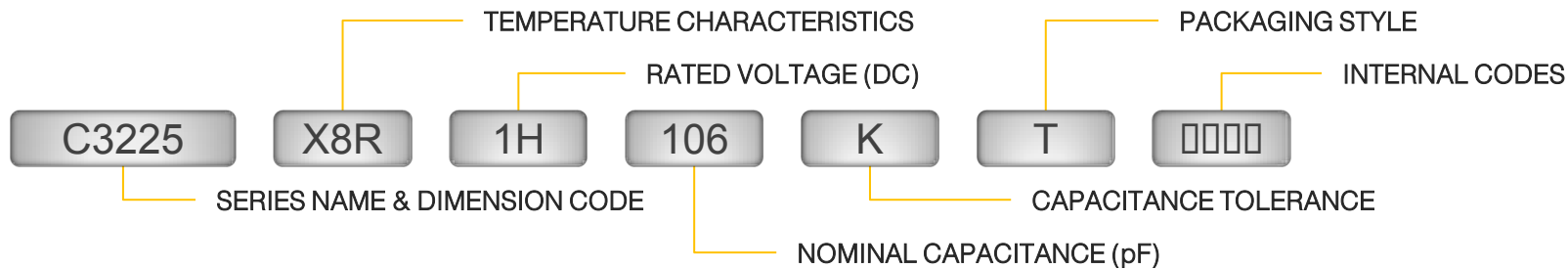

## Features:

- ❖ No polarity
- ❖ Stable temperature characteristics (15%) up to 150°C
- ❖ Highly precise temperature characteristics ( $\pm 7.5\%$ ) up to 125°C

## Applications:

- ❖ Lighting application
- ❖ Measurement instruments used at high temperature environments
- ❖ Smart Meter/Smart Grid
- ❖ LCD/LED backlighting display
- ❖ Industrial application
- ❖ Solar panel micro-inverter

Temperature Characteristic Curve (X7R vs. X8R)

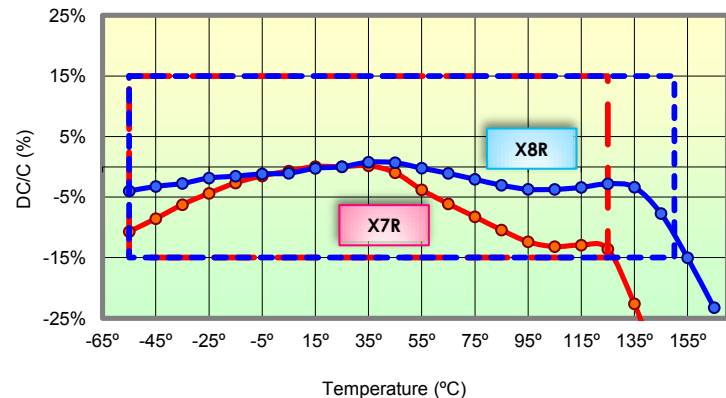

- Temperature characteristics of capacitance is stable ( $\pm 15\%$ ) even at the higher temperature ( $\sim 150^\circ\text{C}$ )
- Temperature characteristics of capacitance shows highly precise performance (capacitance change of  $\pm 7.5\%$ ) up to 125°C

# C SERIES | High Temperature / X8R

Capacitance (pF)	Cap Code	C1005 0402			C1608 0603			C2012 0805				C3216 1206			C3225 1210			
		1H (50V)	1E (25V)	1C (16V)	2A (100V)	1H (50V)	1E (25V)	1C (16V)	2A (100V)	1H (50V)	1E (25V)	1C (16V)	2A (100V)	1H (50V)	1E (25V)	1C (16V)	1E (25V)	1C (16V)
150	151	■																
220	221	■																
330	331	■																
470	471	■																
680	681	■																
1,000	102	■			■	■												
1,500	152	■			■	■												
2,200	222	■			■	■												
3,300	332	■			■	■												
4,700	472	■			■	■												
6,800	682	■	■		■	■												
10,000	103	■	■		■	■												
15,000	153		■		■	■		■										
22,000	223		■		■	■		■										
33,000	333			■	■	■						■						
47,000	473			■	■	■						■						
68,000	683				■	■	■		■			■						
100,000	104				■	■	■		■			■						
150,000	154					■	■		■			■						
220,000	224						■		■			■		■				
330,000	334							■				■		■				
470,000	474							■				■		■				
680,000	684											■		■				
1,000,000	105													■				
1,500,000	155																■	
2,200,000	225																■	
3,300,000	335																■	
4,700,000	475																■	
6,800,000	685																	■
10,000,000	106																	■

■ X8R

# C SERIES | High Q / F&G Tol. Capacitor

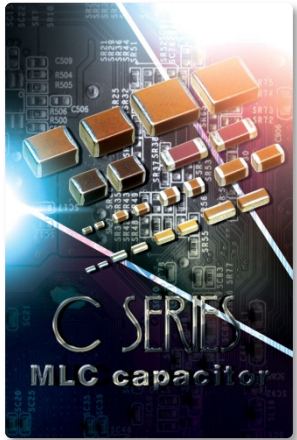

TDK High Q multilayer ceramic chip capacitors (MLCCs) are offered in ultra small metric 0603 (EIA0201) body size. This is offered in C0G temperature characteristics (operating temperature range: -55°C to 125°C), making them ideal for use in higher temperature circuit requirements. C0G is a highly stable material offering temperature stability, low loss, and excellent frequency and voltage performance. This material class also offers excellent attenuation and high self resonant frequency.

High Q series are offered in capacitance tolerance as tight as  $\pm 0.05\text{pF}$  and as wide as  $\pm 5\%$  for higher capacitance value. This series is an excellent solution for mobile multimedia and wireless applications as well as in applications such as but not limited to Bluetooth, GPS, satellite TV and radios.

Case Code	L (mm)	W (mm)	T (mm)
C0603/0201	0.60	0.30	0.30
C1005/0402	1.00	0.50	0.50
C1608/0603	1.60	0.80	0.80

## Part Number Description

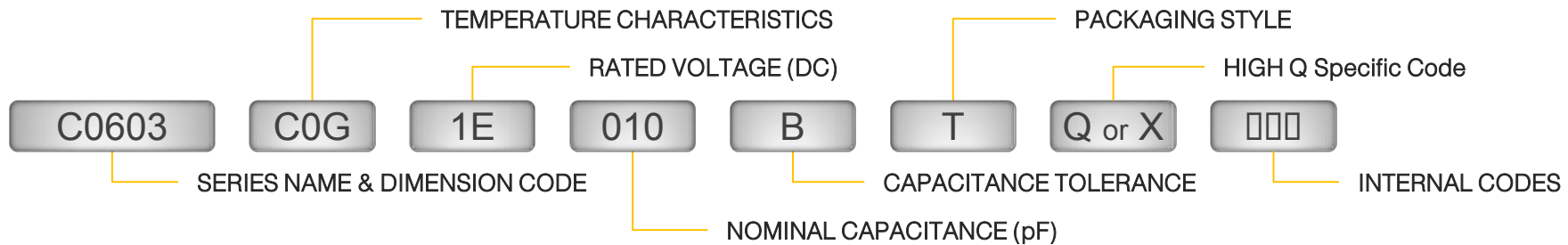

## Features:

- ❖ Higher Q (lower loss) than standard capacitors
- ❖ Available in standard and tight tolerance
- ❖ Same C0G(Class I) BME material
- ❖ Compact case sizes (as small as 0.6 x 0.3 mm)

## Applications:

- ❖ PA module
- ❖ Wireless communications/mobile phones
- ❖ Filter networks/matching networks
- ❖ DC blocking
- ❖ High frequency circuits

Item	Size
Rice	3216
Sesame seed	1005
Strawberry seed	0603

# C SERIES | High Q/Tight Tolerance / COG

Capacitance (pF)	Cap Code	C0603/0201 1E (25V)						
		W	B	E	C	D	G	J
		±0.05pF	±0.10pF	±0.20pF	±0.25pF	±0.50pF	±2%	±5%
0.2	0R2	COG	COG					
0.3	0R3	COG	COG					
0.4	0R4	COG	COG					
0.5	0R5	COG	COG					
0.6	0R6	COG	COG					
0.7	0R7	COG	COG					
0.8	0R8	COG	COG					
0.9	0R9	COG	COG					
1.0	0I0				COG			
1.1	1R1		COG					
1.2	1R2		COG					
1.3	1R3		COG					
1.5	1R5		COG					
1.6	1R6		COG					
1.8	1R8		COG					
2.0	020				COG			
2.2	2R2		COG					
2.4	2R4		COG					
2.7	2R7		COG					
3.0	030				COG			
3.3	3R3		COG					
3.6	3R6		COG					
3.9	3R9		COG					
4.0	040				COG			
4.3	4R3		COG					
4.7	4R7		COG					
5.0	050				COG			
5.1	5R1		COG					
5.6	5R6		COG					
6.0	060				COG			
6.2	6R2		COG					
6.8	6R8		COG					
7.0	070				COG			
7.5	7R5		COG					
8.0	080				COG			
8.2	8R2		COG					
9.0	090				COG			
9.1	9R1		COG					
10	100			COG		COG		
11	110					COG	COG	
12	120					COG	COG	
13	130					COG	COG	
15	150					COG	COG	
16	160					COG	COG	
18	180					COG	COG	
20	200					COG	COG	

COG

Capacitance (pF)	Cap Code	C1005/0402 1H (50V)					
		1H (50V)		2A (100V)			
		F ±1%	G ±2%	F ±1%	G ±2%	F ±1%	G ±2%
15	150	COG	COG	COG	COG		
22	220	COG	COG	COG	COG		
33	330	COG	COG	COG	COG		
47	470	COG	COG	COG	COG		
68	680	COG	COG	COG	COG		
100	101	COG	COG	COG	COG	COG	COG
150	151	COG	COG	COG	COG		
220	221	COG	COG	COG	COG		
330	331	COG	COG	COG	COG		
470	471	COG	COG	COG	COG		
680	681	COG	COG	COG	COG	COG	COG
1,000	102	COG	COG	COG	COG	COG	COG



# C SERIES | Flip Type Capacitor

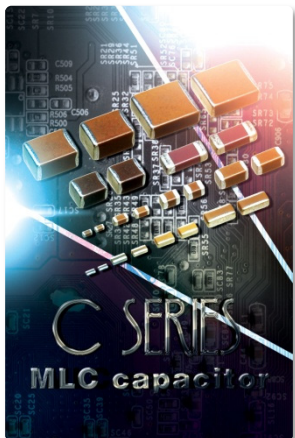

TDK Flip Type capacitor offers industry standard case sizes in “flip” geometry construction. By rotating the orientation of the capacitor 90°, the current path through the unit is shortened and effectively lowers the parasitic inductance value. The flip geometry requires the termination to be applied along the length instead of the width of the MLCC. Reduced ESL is necessary for noise decoupling in high speed applications.

For decoupling capacitors, the parasitic inductance generated by the capacitor needs to be small so that the resonant frequency is higher. The parasitic inductance will add noise voltage spikes to the power line voltage. Because of the unique design of the Flip Type capacitor, the parasitic inductance is lower than the traditional multilayer ceramic capacitor. Therefore, the Flip Type MLCC is very effective for high speed decoupling applications.

Case Code	L (mm)	W (mm)	T max (mm)
C0510 (0204)	0.52	1.00	0.30
C0816 (0306)	0.80	1.60	0.50
C1220 (0508)	1.25	2.00	0.85
C1632 (0612)	1.60	3.20	1.30

## Part Number Description

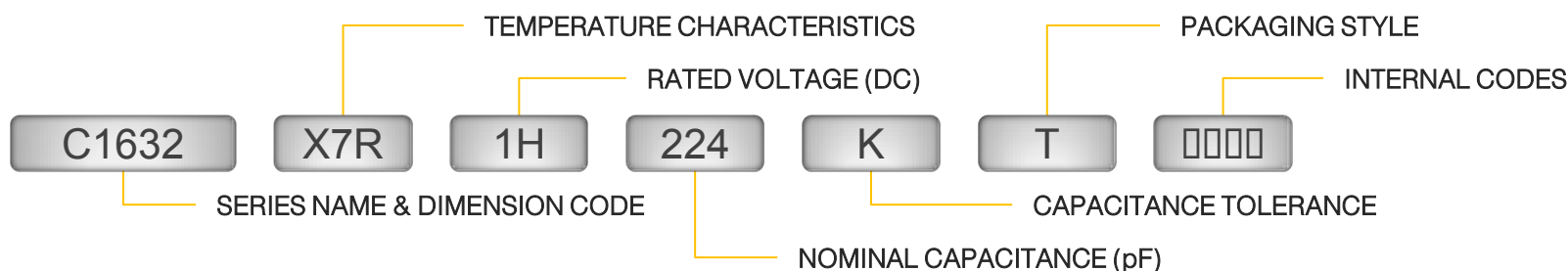

## Features:

- ❖ Flipped geometry provides low inductance (less than 400 pH)
- ❖ Allows adequate high frequency current to IC
- ❖ Provides stabilization of power line voltage
- ❖ High frequency noise suppression

## Applications:

- ❖ Decoupling CPU/GPU power line
- ❖ High speed digital IC power supply decoupling
- ❖ PC, cell phones, camcorders, etc.
- ❖ Smart phone
- ❖ Networking system

## Design Construction of Flip Type Capacitor

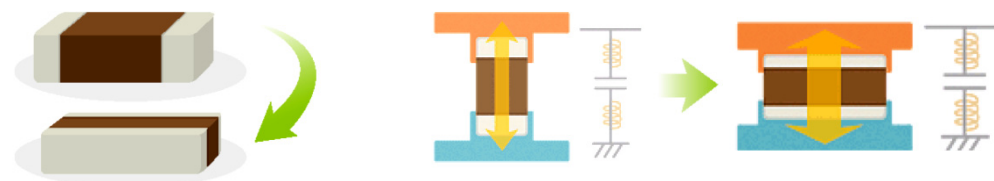

➤ For Flip Type Capacitor, ESL is lowered by reversing the terminal electrode length and width to make the current path short and wide.

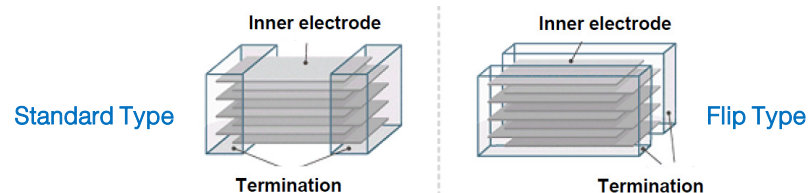

Capacitance (pF)	Cap Code	C0510 0204				C0816 0306				C1220 0508				C1632 0612			
		0G (4V)	1C (16V)	1A (10V)	0J (6.3V)	0G (4V)	1H (50V)	1E (25V)	1C (16V)	1A (10V)	0J (6.3V)	1H (50V)	1E (25V)	1C (16V)	1A (10V)	0J (6.3V)	0G (4V)
10,000	103		1C				1H				1H						
22,000	223		1C				1H				1H						
47,000	473		1C				1H				1H						
100,000	104	0G	1C				1H				1H						
220,000	224		1C	1A	0J		1H				1H						
470,000	474	0G	1C	1A	0J		1H				1H						
1,000,000	105		1C	1A	0J		1H				1H						
2,200,000	225		1C	1A	0J		1H				1H						
4,700,000	475		1C	1A	0J		1H				1H						
10,000,000	106		1C	1A	0J		1H				1H						

■ X5R   
 ■ X6S   
 ■ X7R   
 ■ X7S

## Additional Product Application Information

- Decoupling of high speed integrated circuit
- Smoothing of switching power supply

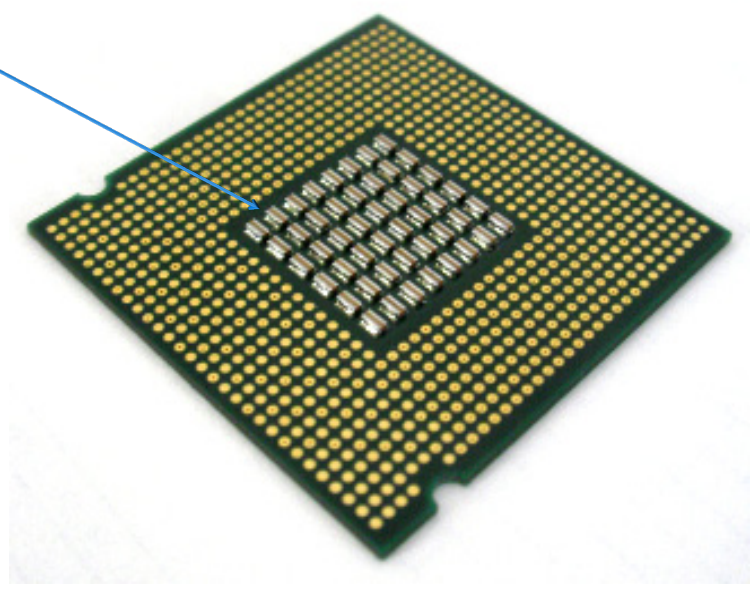
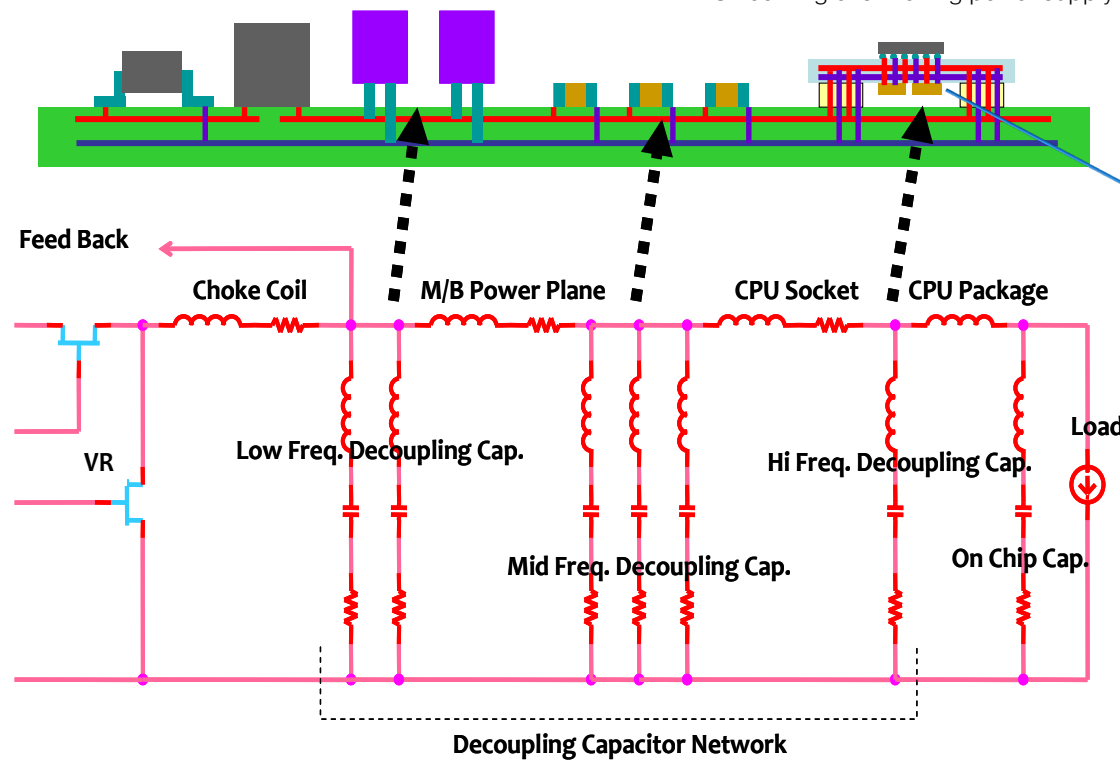

# C SERIES | Open Mode Capacitor

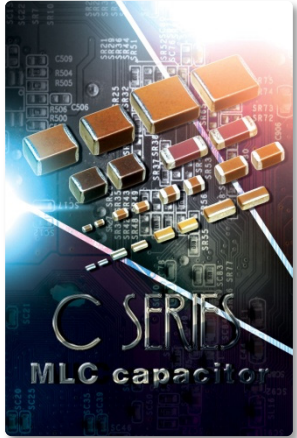

TDK Open Mode Series MLCC is designed to avoid a short circuit when excessive board flex stress causes the ceramic component to crack. By utilizing a unique internal electrode design, the counter electrode avoids the board flex's typical crack path.

Composed of only ceramics and metals, Open Mode Series provides extremely dependable performance, exhibiting virtually no degradation, even when subjected to temperature extremes (X7R and X8R temperature ranges are available). TDK Open Mode MLCCs are available in case sizes 0805, 1206, 1210, 1812, and 2220.

Case Code	L (mm)	W (mm)	T max (mm)
C2012/0805	2.00	1.25	1.25
C3216/1206	3.20	1.60	1.60
C3225/1210	3.20	2.50	2.50
C4532/1810	4.50	3.20	2.30
C5750/2220	5.70	5.00	2.80

## Part Number Description

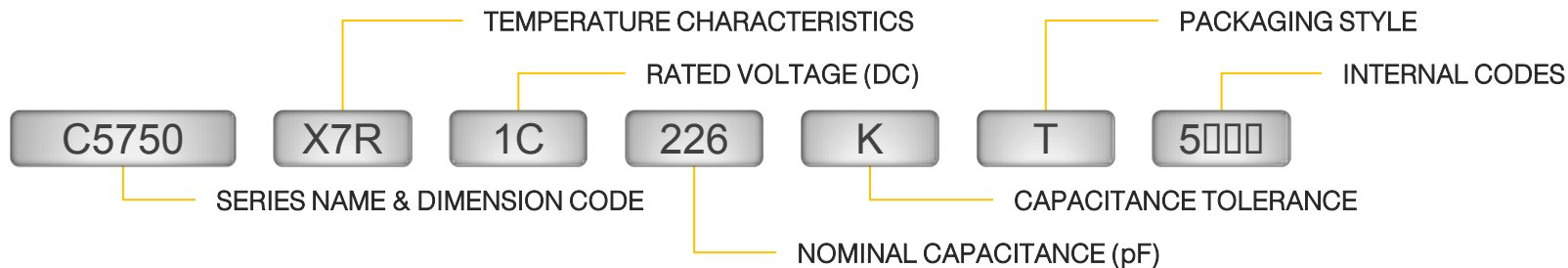

## Features:

- ❖ Increase resistance to mechanical bending, temperature cycle, vibration, and electrical stresses
- ❖ Wider distance between the end of the opposite electrode and the termination
- ❖ Reduces the risk of short circuit failures
- ❖ X7R and X8R temperature ranges

## Applications:

- ❖ High reliability and other high stress applications
- ❖ Battery line circuit with high board flex stress
- ❖ DC-DC converter

### Design Construction of Open Mode Capacitor

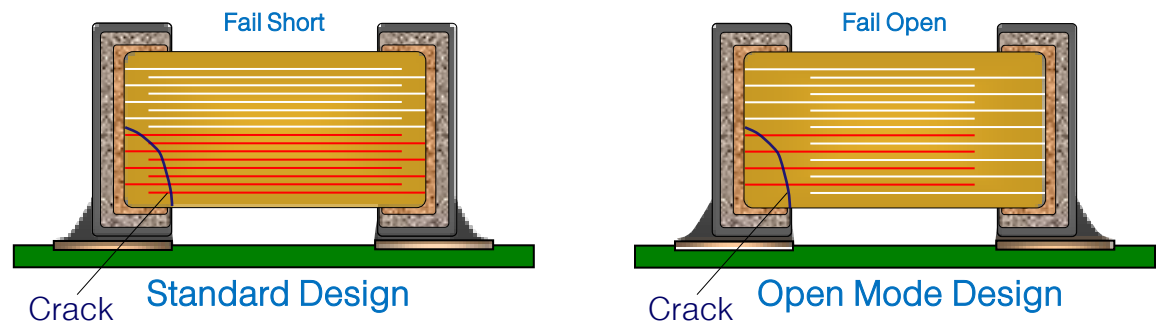

➤ Open Mode capacitor is designed with wider gap between the terminal and the internal electrodes to help reduce the risk of short circuit in the event of capacitor cracking due to mechanical stress such as board bending.

# C SERIES | Open Mode / X8R, X7R

Capacitance (pF)	Cap Code	C2012 0805			C3216 1206			
		2E (250V)	2A (100V)	1H (50V)	2J (630V)	2E (250V)	2A (100V)	1C (16V)
1,000	102	█	█		█			
1,500	152	█	█		█			
2,200	222	█	█		█			
3,300	332	█	█		█			
4,700	472	█	█		█			
6,800	682	█	█		█			
10,000	103	█	█		█			
15,000	153	█	█		█			
22,000	223		█		█	█		
33,000	333			█	█	█		
47,000	473			█	█	█		
68,000	683			█	█	█		
100,000	104			█	█	█		
150,000	154						█	
1,000,000	105							█
4,700,000	475							█

Capacitance (pF)	Cap Code	C3225 1210						C4532 1812						C3225 1210					
		2J (630V)	2E (250V)	2A (100V)	1H (50V)	1E (25V)	1C (16V)	2J (630V)	2E (250V)	2A (100V)	1H (50V)	1E (25V)	1C (16V)	2J (630V)	2E (250V)	2A (100V)	1H (50V)	1E (25V)	1C (16V)
47,000	473	█						█											
68,000	683	█						█											
100,000	104		█										█						
150,000	154		█										█						
220,000	224		█										█						
330,000	334			█										█					
470,000	474				█										█				
680,000	684				█					█						█			
1,000,000	105			█							█					█			
1,500,000	155			█							█								
2,200,000	225			█								█					█		
3,300,000	335												█					█	
4,700,000	475													█					█
6,800,000	685														█				█
10,000,000	106																		█
15,000,000	156																		█
22,000,000	226																		█

█ X7R █ X8R

# C SERIES | Soft Termination Capacitor

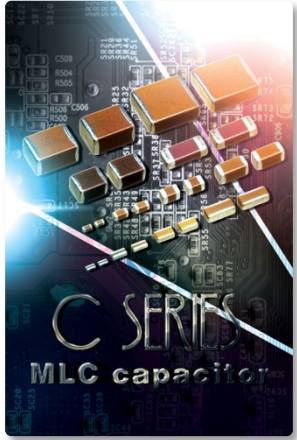

TDK Soft Termination Series is designed for use in applications where significant board flex may occur. Safety/critical automotive applications such as ABS, ESP, airbag, and battery line applications are common examples.

Conventional termination materials used in standard MLCCs are inflexible; therefore vibration, shock, or thermal expansion and contraction have the potential to crack or shear the solder joint between the component and the circuit board. Automotive applications, which are exposed to shock, vibration and extreme temperature swings, can result in higher failure rates in the field with conventional capacitors. TDK's new soft termination provides high resistance to mechanical and thermal stress to ensure the component can meet the requirements of automotive OEMs. Other application such as measurement instruments used in environment with frequent temperature swings can benefit as well.

Case Code	L (mm)	W (mm)	T max (mm)
C2012 (0805)	2.10	1.25	1.25
C3216 (1206)	3.30	1.60	1.60
C3225 (1210)	3.20	2.50	2.50
C4532 (1812)	4.50	3.20	2.50
C5750 (2220)	5.70	5.00	2.50
C7563 (3025)	7.50	6.30	2.70

## Part Number Description

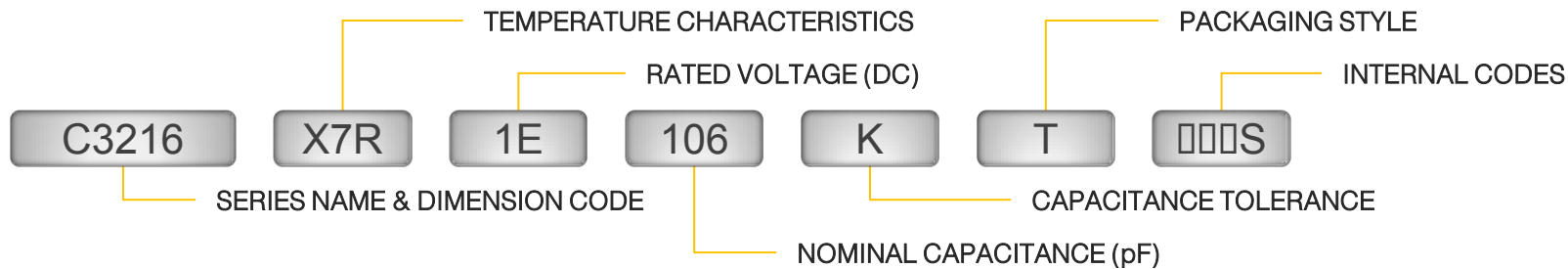

## Features:

- ❖ Improved board bending resistance, drop impact resistance, thermal shock resistance, and heat cycle properties
- ❖ Conductive resin absorb external stress to protect solder joint parts and capacitor body
- ❖ RoHS, WEE, and REACH compliant

## Applications:

- ❖ Switching power supply
- ❖ Telecom base station
- ❖ Electronic circuits mounted on alumina substrate
- ❖ SMT application which requires bending robustness in which solder joint reliability is problematic

### Standard Termination

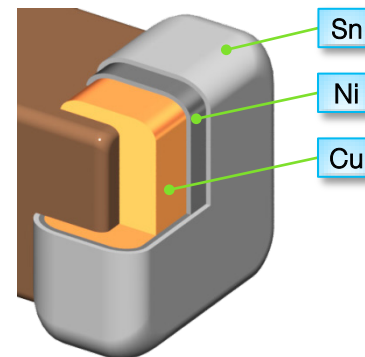

### Soft Termination

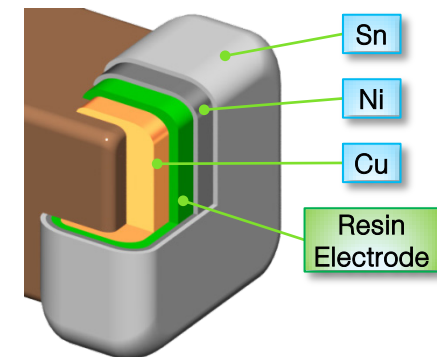

➤ A resin electrode layer between the copper base and the nickel plating of the terminal electrode absorbs bending stress from the board and suppresses the forming of solder cracks. Conductive resin is made of epoxy mixed with a filler of conductive particles.



# C SERIES | Soft Termination / X7R, X7S, X7T

Capacitance (pF)	Cap Code	C2012 0805						C3216 1206						
		2W (450V)	2E (250V)	2A (100V)	1H (50V)	1V (35V)	1C (16V)	2J (630V)	2W (450V)	2E (250V)	2A (100V)	1H (50V)	1V (35V)	1E (25V)
10,000	103	X7T	X7T					X7T						
22,000	223	X7T	X7T					X7T						
47,000	473	X7T	X7T					X7T						
100,000	104		X7T						X7T	X7T				
220,000	224			X7T						X7T				
470,000	474			X7S	X7R						X7R			
1,000,000	105			X7S	X7R						X7R	X7R		
2,200,000	225					X7R						X7R	X7R	
4,700,000	475						X7R					X7S	X7R	
10,000,000	106												X7R	X7R

Capacitance (pF)	Cap Code	C3225 1210					C4532 1812			C5750 2220				C7563 3025	
		2J (630V)	2W (450V)	2E (250V)	2A (100V)	1H (50V)	2J (630V)	2W (450V)	2E (250V)	2J (630V)	2W (450V)	2E (250V)	2A (100V)	1H (50V)	1C (16V)
47,000	473	X7T													
100,000	104	X7T		X7R											
220,000	224		X7T	X7R			X7T								
470,000	474						X7T	X7R	X7T						
1,000,000	105							X7R		X7R	X7R				
2,200,000	225				X7R					X7R		X7R			
4,700,000	475				X7S	X7S									
10,000,000	106					X7S							X7S		
22,000,000	226													X7S	
100,000,000	107													X7S	X7S

■ X7R   
 ■ X7S   
 ■ X7T

# C SERIES | Conductive Epoxy

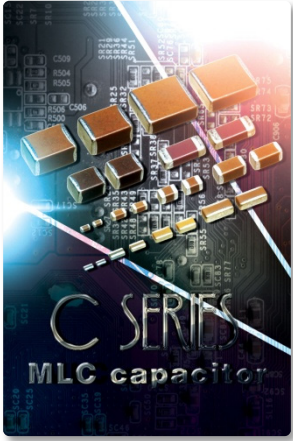

TDK's Conductive Epoxy Series is a conductive glue-mounted device rather than solder-mounted. In high-temperature environments, the connectivity reliability is focused on the solder fillet because there are thermal expansion coefficient differences between the substrate, MLCC, and solder fillet. A conductive glue-mounted device allows for more "flexibility" during periods of expansion and contraction because the thermal expansion differences have been reduced by using a non-solder attachment.

Conductive glue is a common method of mounting components in applications that demand reliability at high temperatures, particularly in automotive environments. It's also used in applications that cannot be subjected to the heat of the solder paste mounting process, such as LCD panels, organic EL and LED displays, and CCD devices, which are particularly sensitive to high temperatures.

Case Code	L (mm)	W (mm)	T (mm)
C1005/0402	1.00	0.50	0.50
C1608/0603	1.60	0.80	0.80
C2012/0805	2.00	1.25	1.25
C3216/1206	3.20	1.60	1.60
C3225/1210	3.20	2.50	2.50

## Part Number Description

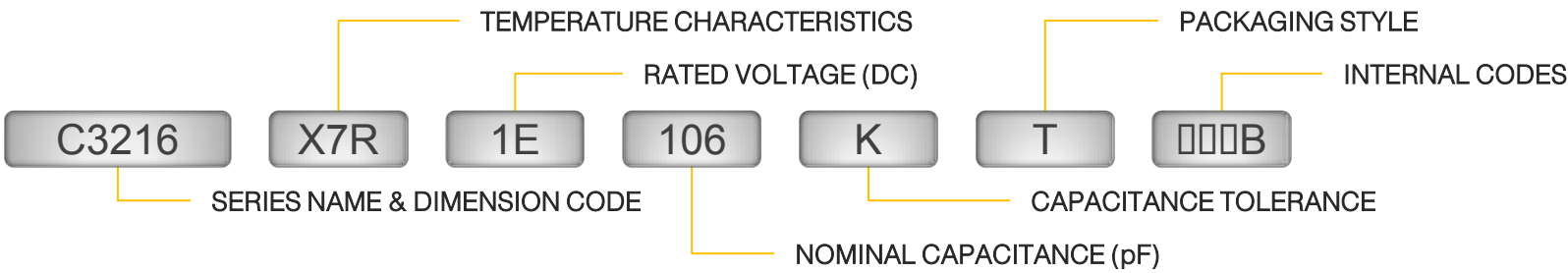

## Features:

- ❖ AgPdCu termination for conductive glue mounting
- ❖ Reduce risk of silver migration
- ❖ Improved mechanical/thermal strength when use with conductive glue
- ❖ AEC Q-200 compliant
- ❖ RoHS, WEE, and REACH compliant

## Applications:

- ❖ Transmission control
- ❖ Engine sensor module
- ❖ Automotive power train
- ❖ Anti-Lock Breaking System
- ❖ Application requiring conductive glue mounting method

Standard Termination

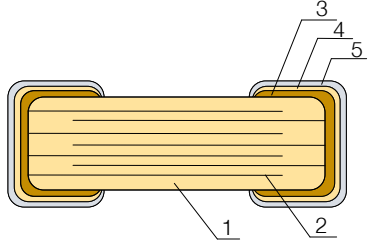

No.	NAME	MATERIAL	
		Class 1	Class 2
(1)	Ceramic Dielectric	CaZrO <sub>3</sub>	BaTiO <sub>3</sub>
(2)	Internal Electrode	Nickel (Ni)	
(3)	Termination	Copper (Cu)	
(4)		Nickel (Ni)	
(5)		Tin (Sn)	

AgPdCu Termination

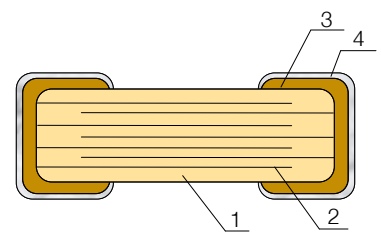

No.	NAME	MATERIAL	
		Class 1	Class 2
(1)	Ceramic Dielectric	CaZrO <sub>3</sub>	BaTiO <sub>3</sub>
(2)	Internal Electrode	Nickel (Ni)	
(3)	Termination	Copper (Cu)	
(4)		AgPdCu	

# C SERIES | Conductive Epoxy / C0G, X7R, X8R

Capacitance (pF)	Cap Code	C1005 0402		C1608 0603			C2012 0805		C3216 1206	C3225 1210	
		1H (50V)	1E (25V)	2A (100V)	1H (50V)		1E (25V)	1H (50V)	1E (25V)	1E (25V)	1H (50V)
10	100	COG									
100	101	COG		COG		COG					
220	221	COG									
470	471	X8R		COG							
1,000	102	X8R		COG	X8R	COG	X7R	X8R			
2,200	222	X8R									
4,700	472	X8R									
10,000	103		X8R		X8R		X7R	X8R			
22,000	223										
47,000	473										
100,000	104					X7R	X8R	X8R			
1,000,000	105								X7R	X8R	X7R
10,000,000	106								X7R	X8R	X7R

█ C0G   
 █ X7R   
 █ X8R

# CGA SERIES | Automotive Grade



TDK CGA series multilayer ceramic chip capacitors (MLCCs) are qualified to automotive industry's Q200 testing standard. CGA parts are manufactured using TDK's most advanced and stable manufacturing process.

Parts are subjected to increased inspections to offer a higher level of life and reliability. The CGA family is available in general voltages up to 50V, mid voltage up to 630V, and high temperature up to 150C. TDK CGA series is an excellent choice for automotive applications as well as any application that requires a higher level of reliability. CGA is also used in tough environment applications such as product that may sit outdoors for the duration of the product life. This includes but is not limited to smart meter, smart grid, base station, etc.

Case Code	L (mm)	W (mm)	T max (mm)
CGA2/0402	1.00	0.50	0.50
CGA3/0603	1.60	0.80	0.80
CGA4/0805	2.00	1.25	1.25
CGA5/1206	3.20	1.60	1.60
CGA6/1210	3.20	2.50	2.50
CGA8/1812	4.50	3.20	3.20
CGA9/2220	5.70	5.00	2.50

L Body Length  
 W Body Width  
 T Body Height  
 B Terminal Width

## Part Number Description

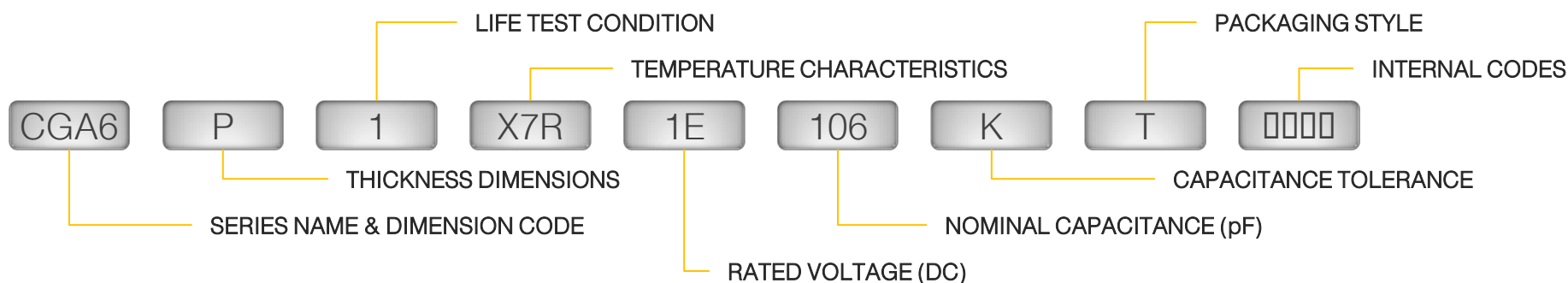

## Features:

- ❖ Qualified to Automotive Q-200
- ❖ Product is manufactured using mature processes
- ❖ Available with rated voltage from 4V – 630V
- ❖ Available in temperature rating up to 150C (X8R)
- ❖ Soft termination available for larger case size

## Applications:

- ❖ Automotive engine control units and sensor modules
- ❖ Automotive battery line smoothing
- ❖ Smart Meter/Smart Grid/Solar Inverters
- ❖ Applications requiring higher reliability
- ❖ Switching power supply smoothing

DC-DC Converters for Hybrid Electric Vehicles

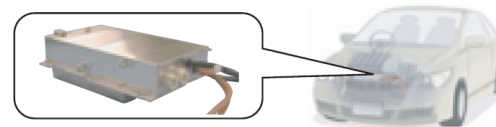
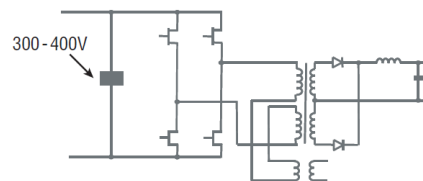

PFC Output Filters

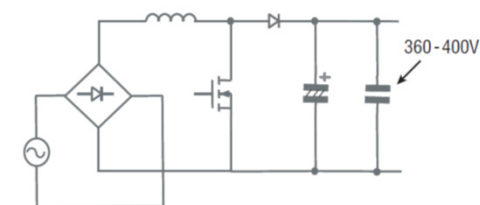













# CGA SERIES | Automotive Grade / COG

Capacitance (pF)	Cap Code	CGA2 0402	CGA3 0603
		1H (50V)	1H (50V)
1.0	010		
1.5	1R5		
2.0	020		
2.2	2R2		
3.0	030		
4.0	040		
4.7	4R7		
5.0	050		
6.0	060		
6.8	6R8		
7.0	070		
8.0	080		
9.0	090		
10	100		
12	120		
15	150		
18	180		
22	220		
27	270		
33	330		
39	390		
47	470		
56	560		
68	680		
82	820		
100	101		
120	121		
150	151		
180	181		
220	221		
270	271		
330	331		
470	471		
560	561		
680	681		
820	821		
1,000	102		
1,200	122		
1,500	152		
1,800	182		
2,200	222		
2,700	272		
3,300	332		
3,900	392		
4,700	472		
5,600	562		
6,800	682		
8,200	822		
10,000	103		

Capacitance (pF)	Cap Code	CGA4 0805	CGA5 1206	CGA6 1210	CGA8 1812
		1H (50V)	1H (50V)	1H (50V)	1H (50V)
100	101				
1,000	102				
2,200	222				
2,700	272				
3,300	332				
3,900	392				
4,700	472				
5,600	562				
6,800	682				
8,200	822				
10,000	103				
15,000	153				
22,000	223				
33,000	333				
47,000	473				
68,000	683				
100,000	104				
150,000	154				
220,000	224				

 COG

# CGA SERIES | Automotive Grade / X5R

Capacitance (pF)	Cap Code	CGA2 0402	CGA3 0603				CGA4 0805			CGA5 1206	
		1H (50V)	1H (50V)	1C (16V)	1A (10V)	0J (6.3V)	1H (50V)	1C (16V)	1A (10V)	1H (50V)	1V (35V)
220,000	224										
1,000,000	105										
2,200,000	225										
3,300,000	335										
4,700,000	475										
10,000,000	106										

 X5R



Capacitance (pF)	Cap Code	CGA2 0402					CGA3 0603				
		1H (50V)	1V (35V)	1E (25V)	1C (16V)	1A (10V)	1H (50V)	1V (35V)	1E (25V)	1C (16V)	0J (6.3V)
220	221	█					█				
330	331	█					█				
470	471	█					█				
680	681	█					█				
1,000	102	█					█				
1,500	152	█					█				
2,200	222	█					█				
3,300	332	█					█				
4,700	472	█					█				
6,800	682	█					█				
10,000	103	█	█	█			█				
15,000	153	█		█			█				
22,000	223	█		█			█				
33,000	333	█		█			█				
47,000	473	█		█	█		█				
68,000	683	█	█	█	█		█				
100,000	104	█	█	█	█		█		█		
150,000	154						█		█		
220,000	224						█		█		
330,000	334							█		█	
470,000	474							█		█	
680,000	684								█	█	
1,000,000	105								█		
1,500,000	155										
2,200,000	225										█

Capacitance (pF)	Cap Code	CGA4 0803					CGA5 1206					CGA6 1210			CGA8 1812			CGA9 2220			
		1H (50V)	1V (35V)	1E (25V)	1C (16V)	0J (6.3V)	1H (50V)	1V (35V)	1E (25V)	1C (16V)	0J (6.3V)	1H (50V)	1E (25V)	1C (16V)	1H (50V)	1E (25V)	1C (16V)	1H (50V)	1E (25V)	1C (16V)	
100,000	104	█																			
150,000	154	█																			
220,000	224	█		█																	
330,000	334	█		█																	
470,000	474	█		█	█		█														
680,000	684	█	█	█	█		█														
1,000,000	105	█	█	█	█		█		█	█		█									
1,500,000	155						█					█									
2,200,000	225		█				█					█									
3,300,000	335		█					█				█									
4,700,000	475			█	█			█				█									
6,800,000	685											█		█							
10,000,000	106											█		█							
15,000,000	156																				
22,000,000	226																				
33,000,000	336																				
47,000,000	476																				█

█ X7R █ X7S

# CGA SERIES | High Temperature / X8R

Capacitance (pF)	Cap Code	CGA2 0402		CGA3 0603			CGA4 0805			CGA5 1206			CGA6 1210
		1H (50V)	1E (25V)	2A (100V)	1H (50V)	1E (25V)	2A (100V)	1H (50V)	1E (25V)	2A (100V)	1H (50V)	1E (25V)	1E (25V)
150	151	■											
220	221	■											
330	331	■											
470	471	■											
680	681	■											
1,000	102	■		■	■								
1,500	152	■		■	■								
2,200	222	■		■	■								
3,300	332	■		■	■								
4,700	472	■		■	■								
6,800	682		■	■	■								
10,000	103		■	■	■								
15,000	153			■	■		■						
22,000	223				■		■						
33,000	333				■								
47,000	473				■								
68,000	683					■		■		■			
100,000	104					■		■		■			
150,000	154									■			
220,000	224									■			
330,000	334										■		
470,000	474										■		
680,000	684											■	
1,000,000	105												■
1,500,000	155												■
2,200,000	225												■
3,300,000	335												■

■ X8R

# CGA SERIES | Mid Voltage / C0G

Capacitance (pF)	Cap Code	CGA3 0603		CGA4 0805		CGA5 1206			CGA6 1210			CGA8 1812		
		2E (250V)	2A (100V)	2E (250V)	2A (100V)	2J (630V)	2E (250V)	2A (100V)	2J (630V)	2E (250V)	2A (100V)	2J (630V)	2E (250V)	2A (100V)
100	101	COG	COG		COG	COG								
120	121													
150	151													
180	181													
220	221				COG									
270	271													
330	331													
390	391				COG									
470	471				COG									
560	561													
680	681	COG												
820	821			COG	COG									
1,000	102		COG	COG	COG									
1,200	122		COG											
1,500	152			COG	COG									
1,800	182													
2,200	222			COG	COG									
2,700	272			COG	COG	COG								
3,300	332					COG	COG	COG						
3,900	392						COG	COG						
4,700	472				COG									
5,600	562					COG	COG	COG						
6,800	682													
8,200	822					COG	COG				COG			
10,000	103						COG		COG		COG			
15,000	153								COG	COG				
22,000	223									COG	COG	COG		
33,000	333													
47,000	473										COG			
68,000	683											COG		
100,000	104													COG

COG

# CGA SERIES | Mid Voltage / X7R, X7S, X7T

Capacitance (pF)	Cap Code	CGA2 0402	CGA3 0603	CGA4 0805			CGA5 1206			
		2A (100V)	2A (100V)	2W (450V)	2E (250V)	2A (100V)	2J (630V)	2W (450V)	2E (250V)	2A (100V)
1,000	102	X7R	X7R				X7R			
1,500	152	X7R	X7R				X7R			
2,200	222	X7R	X7R				X7R			
3,300	332	X7R	X7R				X7R			
4,700	472	X7R	X7R				X7R			
6,800	682	X7R	X7R			X7R				
10,000	103	X7R	X7R			X7R				
15,000	153		X7R	X7R	X7R	X7R	X7R		X7R	
22,000	223		X7R	X7R	X7R	X7R	X7R		X7R	
33,000	333		X7S	X7R	X7R	X7R	X7R		X7R	X7R
47,000	473		X7R	X7R	X7R	X7R	X7R		X7R	X7R
68,000	683		X7S		X7R	X7R			X7R	X7R
100,000	104		X7S		X7R	X7R		X7R	X7R	X7R
150,000	154								X7R	X7R
220,000	224								X7R	X7R
330,000	334									X7R
470,000	474					X7S				X7R
1,000,000	105					X7S				X7R
2,200,000	225					X7S				X7S

Capacitance (pF)	Cap Code	CGA6 1210				CGA8 1812				CGA9 2220			
		2J (630V)	2W (450V)	2E (250V)	2A (100V)	2J (630V)	2W (450V)	2E (250V)	2A (100V)	2J (630V)	2W (450V)	2E (250V)	2A (100V)
47,000	473	X7R				X7R							
68,000	683	X7R				X7R							
100,000	104	X7R		X7R		X7R							
150,000	154		X7R	X7R		X7R		X7R	X7R				
220,000	224		X7R	X7R		X7R		X7R	X7R				
330,000	334				X7R		X7R		X7R			X7R	
470,000	474				X7R		X7R		X7R			X7R	
680,000	684				X7R		X7R		X7R		X7R	X7R	
1,000,000	105				X7R		X7R		X7R		X7R	X7R	X7R
1,500,000	155											X7R	X7R
2,200,000	225											X7R	X7R
3,300,000	335											X7R	X7R
4,700,000	475											X7S	X7R
10,000,000	106											X7S	X7R
15,000,000	156											X7S	X7R

 X7R  X7S  X7T

# CGA SERIES | Soft Termination / X7R, X7S, X7T

Capacitance (pF)	Cap Code	CGA4 0805						CGA5 1206						
		2W (450V)	2E (250V)	2A (100V)	1H (50V)	1V (35V)	1C (16V)	2J (630V)	2W (450V)	2E (250V)	2A (100V)	1H (50V)	1V (35V)	1E (25V)
10,000	103	X7T	X7T					X7T						
22,000	223	X7T	X7T					X7T						
47,000	473	X7T	X7T					X7T	X7T	X7T				
100,000	104		X7T						X7T	X7T				
220,000	224			X7T						X7T				
470,000	474			X7T	X7R						X7R			
1,000,000	105			X7T	X7R						X7R	X7R		
2,200,000	225					X7R						X7R	X7R	
4,700,000	475						X7R					X7T	X7R	
10,000,000	106													X7R

Capacitance (pF)	Cap Code	CGA6 1210					CGA8 1812			CGA9 2220			
		2J (630V)	2W (450V)	2E (250V)	2A (100V)	1H (50V)	2J (630V)	2W (450V)	2E (250V)	2J (630V)	2W (450V)	2E (250V)	2A (100V)
47,000	473	X7T											
100,000	104	X7T		X7T									
220,000	224		X7T	X7T			X7T						
470,000	474						X7T	X7T	X7T				
1,000,000	105							X7T		X7T	X7T	X7R	
2,200,000	225				X7R						X7T	X7T	
4,700,000	475				X7T	X7T							
10,000,000	106					X7T							X7T
22,000,000	226												
100,000,000	107												

■ X7R   
 ■ X7S   
 ■ X7T

# CGJ SERIES | Extended Life MLCC



TDK's CGJ Series MLCC provides an extended life MLCC that meets electrical, mechanical, and environmental performance standards from multiple industry specifications. The enhanced reliability design allows its use in higher reliability applications in which maximum field life and the highest quality standards are required, as well as for applications demanding performance levels beyond typical commercial grade and automotive grade performance.

In addition to our highest quality MLCC's, the customer will also receive a Certificate of Analysis with each lot (which includes electrical characterization data and estimated product life) and anti-counterfeit packaging. Additionally, RFID (radio frequency identification) tags are available as an option. The Certificate of Analysis and Product Authentication are available on-line at TDK.com.

Case Code	L (mm)	W (mm)	T (mm)
CGJ2 / 0402	1.00	0.50	0.50
CGJ3 / 0603	1.60	0.80	0.80
CGJ4 / 0805	2.00	1.25	0.60
	2.00	1.25	1.25
CGJ5 / 1206	3.20	1.60	0.60
	3.20	1.60	0.85
	3.20	1.60	1.15
	3.20	1.60	1.60

L Body Length  
 W Body Width  
 T Body Height  
 B Terminal Width

## Part Number Description

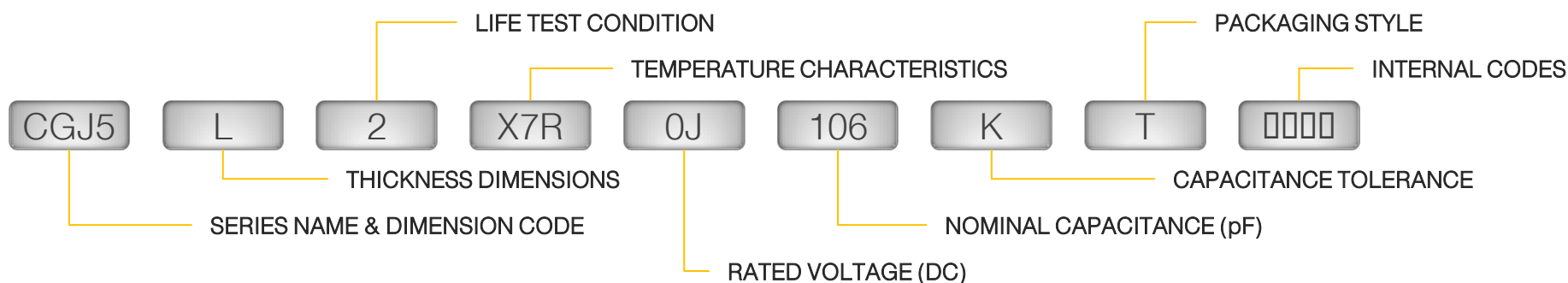

## Features:

- ❖ Extensive testing to ensure higher reliability and longer life
- ❖ Reliability tests based on MIL-STD requirements
- ❖ Guaranteed TC Bias and Hot IR performance
- ❖ Certificate of Compliance documentation is provided for each CGJ lot. Consumers of CGJ products can view each lot specific CoA on the TDK website
- ❖ UHF (Ultra High Frequency) RFID tag to allow integration with customer RFID programs such as inventory management
- ❖ Tamper proof seal to assist in the identification of authentic TDK CGJ products. The condition of the seal also indicates if the product has been tampered with in the supply chain
- ❖ CGJ customer priority backed by TDK factory support (3/3/7)

## Applications:

- ❖ Smart Meter
- ❖ Smart Grid
- ❖ Industrial Application
- ❖ Telecom Base Station
- ❖ LED Lighting
- ❖ Solar Micro-inverters
- ❖ Charging station
- ❖ Military Communication Equipment
- ❖ Class 1 & 2 Medical Equipment
- ❖ Applications that require extended life performance



# CGJ SERIES | Extended Life MLCC / COG, X7R

Capacitance (pF)	Cap Code	CGJ2 C1005/CC0402			CGJ3 C1608/CC0603					CGJ4 C2012/CC0805					CGJ5 C3216/CC1206				
		1H (50V)	1E (25V)	1C (16V)	1H (50V)	1E (25V)	1C (16V)	1A (10V)	0J (6.3V)	1H (50V)	1E (25V)	1C (16V)	1A (10V)	0J (6.3V)	1H (50V)	1E (25V)	1C (16V)	1A (10V)	0J (6.3V)
100	101	COG																	
120	121	COG																	
150	151	COG																	
180	181	COG																	
220	221																		
270	271				COG														
330	331				COG														
390	391	COG																	
470	471	COG																	
560	561																		
680	680									COG									
820	821	COG																	
1,000	102	COG	X7R	X7R						COG									
1,200	122																		
1,500	152		X7R	X7R															
1,800	182		X7R	X7R															
2,200	222		X7R	X7R															
2,700	272		X7R	X7R															
3,300	332		X7R	X7R															
3,900	392		X7R	X7R															
4,700	472		X7R	X7R															
5,600	562		X7R	X7R															
6,800	682		X7R	X7R															
8,200	822																		
10,000	103		X7R	X7R		COG	COG	COG											
15,000	153		X7R	X7R															
22,000	223					COG	COG	COG											
33,000	333									COG	COG	COG							
47,000	473																		
68,000	683																		
100,000	104			X7R		COG	COG	COG						COG					
150,000	154																		
220,000	224																		
330,000	334																		
470,000	474																		
680,000	684																		
1,000,000	105																		
1,500,000	155																		
2,200,000	225																		
3,300,000	335																		
4,700,000	475																		
6,800,000	685																		
10,000,000	106																		

COG X7R

# CKG SERIES | Mega Capacitor



TDK Mega Cap utilizes an alloy 42 lead frame connected to the ends of MLCCs in single or double stacked (piled) configuration. The lead frame absorbs external stresses which allow a more robust performance. Effectively the lead frame allows external stresses beyond the typical allowable range for a traditional MLCC.

Mega Caps are excellent choices for high board flex applications as well as physically large boards that are highly susceptible to flexure. Other flex solutions are designed to resist short circuit but still cause the capacitor to fail intermittently or completely but the Mega Cap has a greater degree of flexure resistance without capacitor failure. Compared to electrolytic capacitors, Mega Cap offers lower ESL, ESR, and improved frequency response and since Mega Cap is an MLCC, they have no polarity. Other advantages include higher capacitance with higher voltage rating due to stacking the capacitors in parallel configuration.

Case Code	L (mm)	W (mm)	T (mm)
CKG32K (Single)	3.50	2.60	3.35
CKG45K (Single)	5.00	3.50	2.90
CKG57K (Single)	6.00	5.00	3.35
CKG45N (Double)	5.00	3.50	5.00
CKG57N (Double)	6.00	5.00	5.00

## Part Number Description

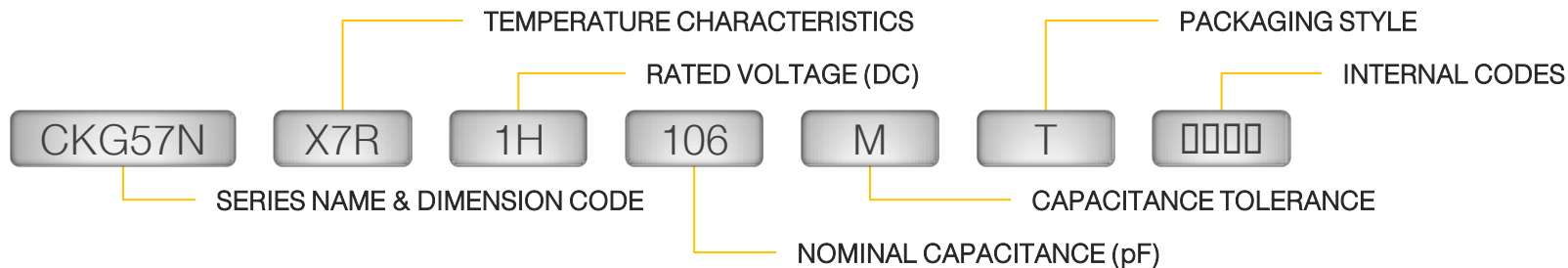

## Features:

- ❖ Twice the capacitance on single capacitor foot print
- ❖ Lower ESR and ESL than Al caps
- ❖ Capable of absorbing thermal and mechanical stress
- ❖ Improved heat generation by ripple current
- ❖ Improved vibration performance

## Applications:

- ❖ Smoothing circuits
- ❖ DC/DC converters
- ❖ HID/Automotive applications
- ❖ Temperature variable applications
- ❖ Piezoelectric-effect countermeasure

## Design Concept & Construction of Mega Capacitor

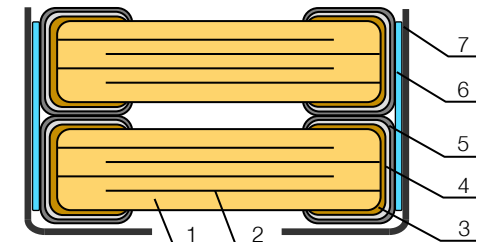
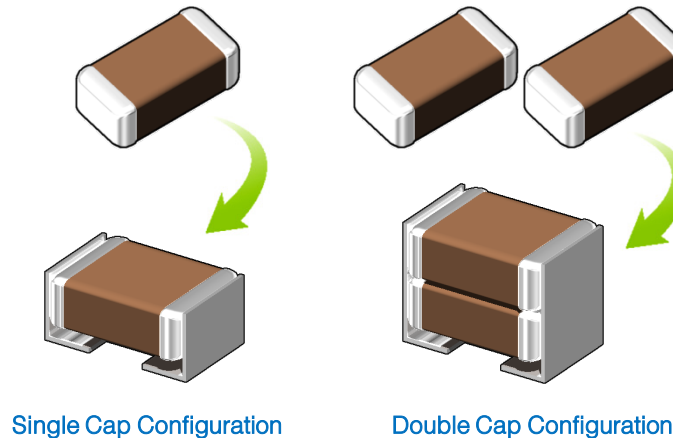

No.	NAME	MATERIAL
		<b>Class 2</b>
(1)	Ceramic Dielectric	BaTiO <sub>3</sub>
(2)	Internal Electrode	Nickel (Ni)
(3)		Copper (Cu)
(4)	Termination	Nickel (Ni)
(5)		Tin (Sn)
(6)	Metal Cap Joint	High Temp Solder
(7)	Metal Cap	42 Alloy

# CKG SERIES | Mega Capacitor / X7R, X7S, X7T, X5R

Capacitance (pF)	Cap Code	CKG32K (Single) 1210/C3225						CKG45K (Single) 1812/C4532						CKG57K (Single) 2220/C5750								
		2J (630V)	2W (450V)	2E (250V)	2A (100V)	1H (50V)	1E (25V)	2J (630V)	2W (450V)	2E (250V)	2A (100V)	1H (50V)	1E (25V)	1C (16V)	2J (630V)	2W (450V)	2E (250V)	2A (100V)	1H (50V)	1E (25V)	1C (16V)	
47,000	473	█																				
100,000	104			█				█														
150,000	154	█																				
220,000	224		█	█				█		█					█							
330,000	334		█	█											█							
470,000	474								█	█					█		█	█				
1,000,000	105									█						█		█				
2,200,000	225																█	█				
3,300,000	335																					
4,700,000	475																					
10,000,000	106																					
22,000,000	226																					
47,000,000	476																					

Capacitance (pF)	Cap Code	CKG45N (Double) 1812/C4532							CKG57N (Double) 2220/C5750													
		2J (630V)	2W (450V)	2E (250V)	2A (100V)	1H (50V)	1E (25V)	1C (16V)	2J (630V)	2W (450V)	2E (250V)	2A (100V)	1H (50V)	1E (25V)	1C (16V)							
220,000	224	█																				
470,000	474	█																				
1,000,000	105		█	█																		
2,200,000	225			█	█																	
3,300,000	335																					
4,700,000	475																					
6,800,000	685																					
10,000,000	106																					
22,000,000	226																					
33,800,000	336																					
47,000,000	476																					
100,000,000	107																					

█ X7R █ X7S █ X7T █ X5R

# CKC SERIES | Array Capacitor



TDK CKC Series Array Capacitor offers multiple multilayer ceramic chip capacitors (MLCCs) in a single compact package. TDK's unique design offers lower cross talk which truly function as separate individual capacitors in a single package. Arrays are offered in 2-in-1 and 4-in-1 package styles.

Capacitor arrays are mainly used to reduce board space and component count as well as reducing placement time and warehouse/storage space. Capacitor arrays are also commonly used for noise decoupling. Today's higher density circuits, increased feature designs, and smaller product sizes force designers to find ways to reduce component count simply due to the fact of no available board space. TDK's Array caps offer to fix this problem with our advance layering technique and innovative multilayer capacitor design. Capacitor arrays also allow decoupling capacitors to be placed closer to high speed ICs/ASICs which reduces trace inductance.

Case Code	L (mm)	W (mm)	T (mm)	C (mm)	P (mm)
CKCM25	1.37	1.00	0.60	0.36	0.66
	1.37	1.00	0.80	0.36	0.66
CKCL22	2.00	1.25	0.85	0.45	1.00
CKCL44	2.00	1.25	0.85	0.25	1.00
CKCA43	3.20	1.60	1.00	0.40	1.10

## Part Number Description

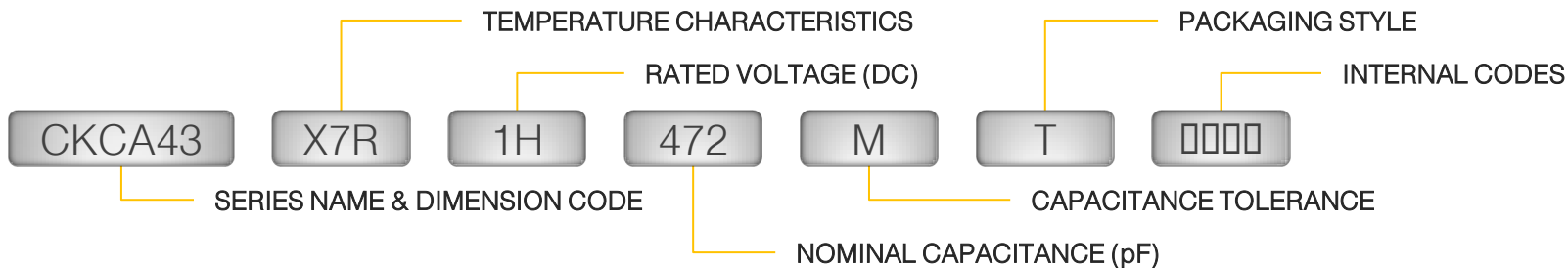

## Features:

- ❖ Available as 2-in-1 and 4-in-1 package
- ❖ Reduced PCB space and mounting time
- ❖ Unique electrode construction reduces crosstalk
- ❖ 2-in-1 design also available in soft termination

## Applications:

- ❖ Around interface cable in PC
- ❖ CPU bus line
- ❖ Cellular phone interface

### Array Capacitor Design Concept

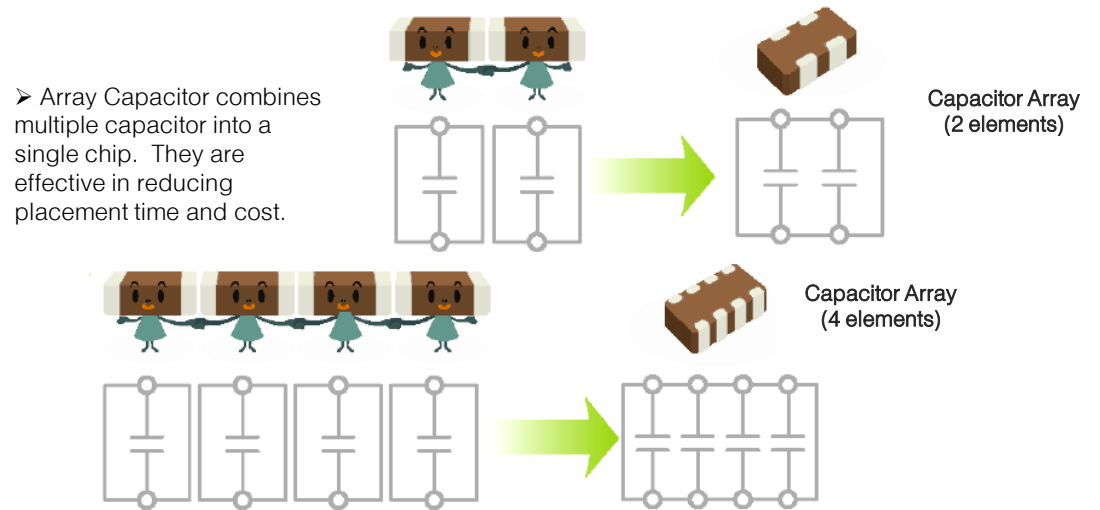

Capacitance (pF)	Cap Code	CKCM25 (2-in-1) 0504/C1410					CKCL22 (2-in-1) 0805/C2012				
		1H (50V)	1E (25V)	1C (16V)	1A (10V)	0J (6.3V)	1H (50V)	1E (25V)	1C (16V)	1A (10V)	0J (6.3V)
10	100	COG					COG				
15	150										
22	220										
33	330										
47	470										
68	680										
100	101	COG					COG				
150	151										
220	221										
330	331										
470	471										
1,000	102	X7R					X7R				
2,200	222	X7R					X7R				
4,700	472		X7R								
10,000	103		X7R								
22,000	223			X5R							
47,000	473				X5R						
100,000	104					X5R		X7R	X5R		
220,000	224								X5R		
470,000	474									X5R	
1,000,000	105					X5R					X5R
2,200,000	225										X5R

Capacitance (pF)	Cap Code	CKCL44 (4-in-1) 0805/C2012					CKCA43 1206/C3216			
		1H (50V)	1E (25V)	1C (16V)	1A (10V)	0J (6.3V)	1H (50V)	1E (25V)	1C (16V)	0J (6.3V)
10	100	COG					COG			
15	150									
22	220									
33	330									
47	470									
68	680									
100	101	COG					COG			
150	151									
220	221	X7R					X7R			
330	331							X7R		
470	471	X7R					X7R			
680	681									
1,000	102	X7R					X7R			
2,200	222							X7R		
4,700	472	X7R								
10,000	103		X7R					X7R		
22,000	223			X7R				X7R		
47,000	473				X5R			X7R	X5R	
100,000	104					X5R			X7R	X5R
1,000,000	105									X5R

█ C0G   
 █ X7R   
 █ X5R

# CER SERIES | Controlled ESR

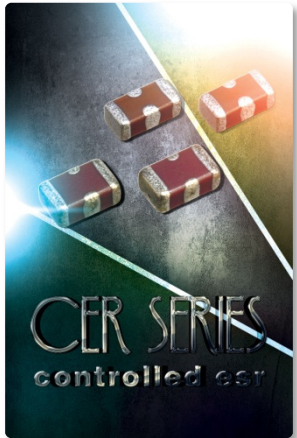

TDK's CER multilayer ceramic chip capacitor series offers the unique additional function of controlling the ESR (equivalent series resistance) value as desired without affecting ESL (equivalent series inductance). This function enables control of voltage change, which can occur between the power source and the CPU, by controlling the impedance of the capacitors located around the CPU.

The relatively low ESR value of standard MLCCs can be too low in cases where the MLCC has replaced a Tantalum capacitors. Designer can avoid the additional resistor typically used to solve this problem by utilizing CER Series capacitors. This can contribute to cost saving due to less cost during production. The mounting method of the CER Series is the same as products with two terminals, which makes replacement of existing products with CER chip capacitor very easy.

Case Code	L (mm)	W (mm)	T (mm)	B (mm)	P (mm)
CERB	1.60	0.80	0.80	0.10	0.20
CERD	2.00	1.25	0.85	0.30	0.20

## Part Number Description

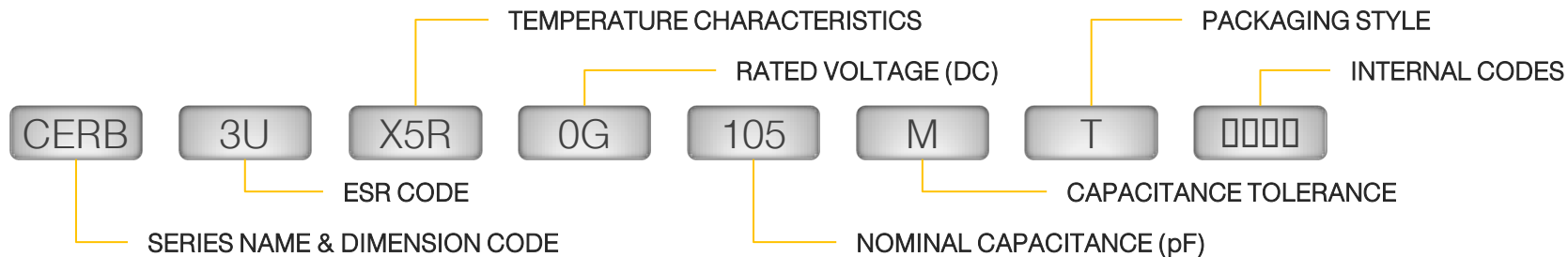

## Features:

- ❖ Design allows for ESR to be controlled using unique internal structure without affecting ESL
- ❖ Control of voltage variations eliminates effects on the stability of current signals and impact on other circuits
- ❖ Same mounting method as 2-terminal components
- ❖ Flatness of impedance characteristics is enhanced through additional resistance components, reducing the number of components by 50%

### MLCC Design ESR Comparison

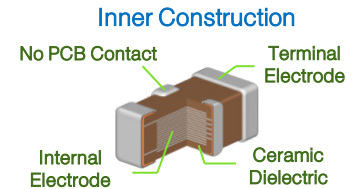
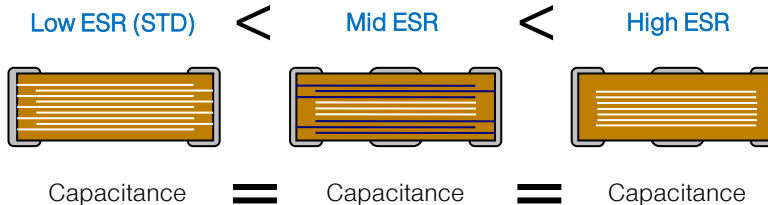

## Applications:

- ❖ DC to DC converter input/output smoothing
- ❖ Voltage regulator
- ❖ IC power supply circuit decoupling

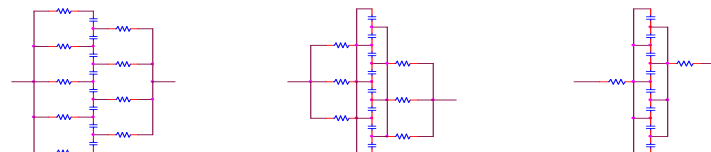

### Equivalent Circuit

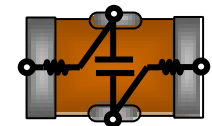



Capacitance (pF)	Cap Code	CERB 0603/C1608			CERD 0805/C2012				
		0G (4V)			0G (4V)				
		2C (200mΩ)	2M (650mΩ)	3U (1.2Ω)	1C (20mΩ)	1J (50mΩ)	2A (100mΩ)	2C (200mΩ)	2J (500mΩ)
1,000,000	105								
10,000,000	106								
22,000,000	226								

X5R

## Additional Product Application Information

➤ Excessively low ESR with traditional MLCC may negatively affect decoupling at the CPU level which is powered by high current and low voltage. Several capacitors with different self-resonant frequency are used at power circuit of CPU to make impedance lower at wide band and to control voltage fluctuation toward high frequency current. However, excessively lower ESR of MLCC may cause sharp impedance peak by parallel resonance between MLCCs, high frequency current which corresponds to the frequency will change PS voltage and cause malfunction. CPU decoupling MLCC with appropriate ESR will obtain flat impedance and control CPU voltage fluctuation.

➤ CERB (0603) series capacitor has maximum resistance of 1200mΩ and the CERD (0805) series capacitor has maximum resistance of 500mΩ, ideal for using as decoupling capacitors.

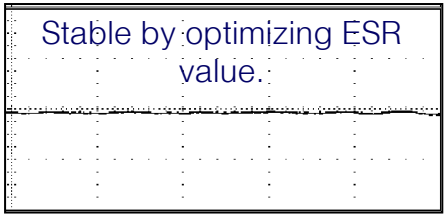
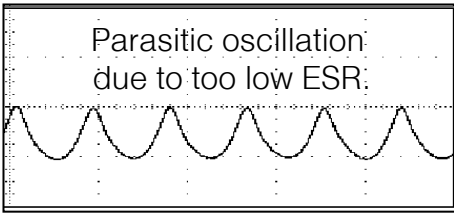
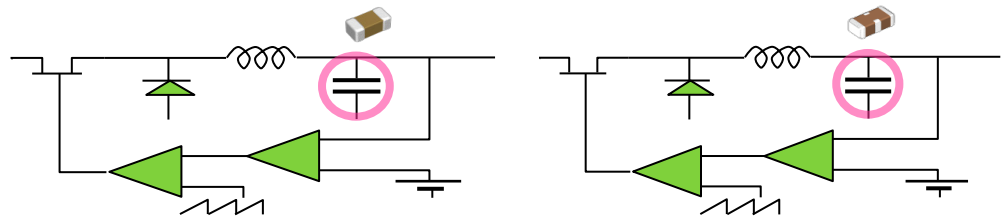

➤ Optimal ESR Value selection can prevent parasitic oscillation and secure phase margin

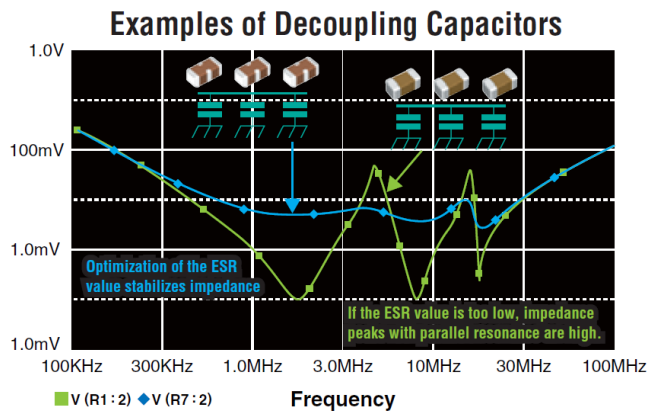
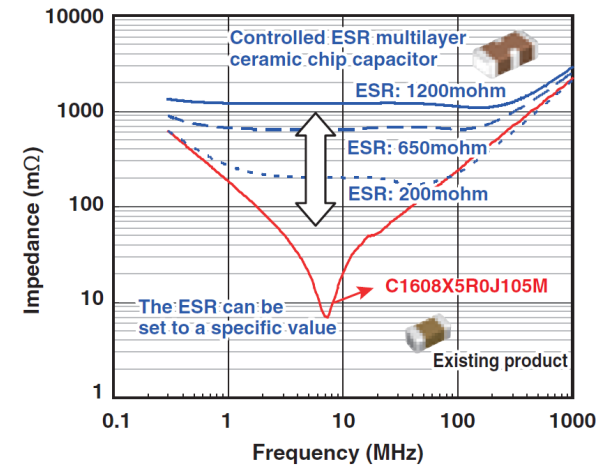

# CEU SERIES | Serial Design



Automotive design often employs two distinct capacitors in a series on the PCB for power supply and battery line to protect the circuit from a short in case of cracking of the MLCC. In conjunction with our existing soft electrode technology, TDK offers 2 capacitors in single body construction in our CEU product line for ultra high reliability. Serial construction of inner electrode prevents sudden insulation breakdown after flex crack formation and soft termination technology allows for better absorption of external stress and protects the ceramic body. The combination of these technologies yield improved voltage and ESD performance over standard designs and decrease risk of short circuit failures and low IR due to mechanical flex cracks. Soft termination also allow for better performance with thermal expansion and contraction.

L Body Length  
 W Body Width  
 T Body Height  
 B Terminal Width

Case Code	L (mm)	W (mm)	T (mm)	Life Test Conditions
CEU3E2 (0603)	1.60	0.80	0.80	WV x 2
CEU4J2 (0805)	2.10	1.25	1.25	WV x 2

## Part Number Description

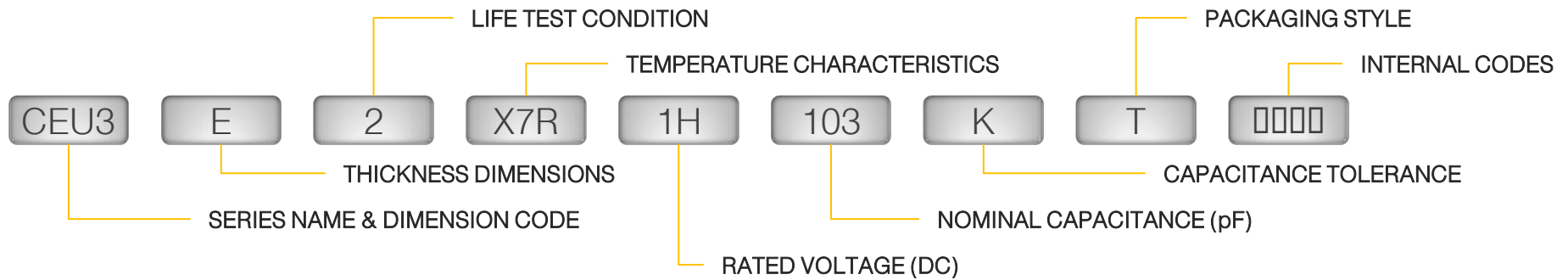

## Features:

- ❖ Improved bending resistance (Board Flex Resistance)
- ❖ Improved temperature cycle performance
- ❖ Allow space reduction on PCB
- ❖ Ultra high reliability
- ❖ RoHS, WEE, and REACH compliant

## Applications:

- ❖ Power supply without protective circuit
- ❖ Automotive battery line

### Ultra High Reliability Features!

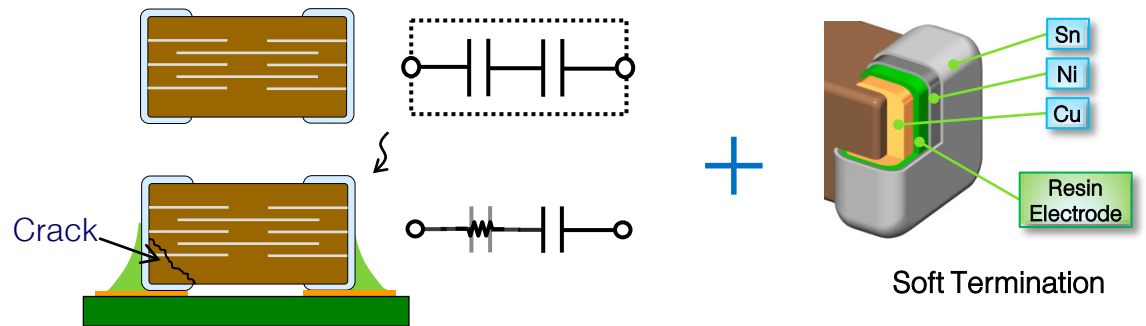

➤ Serial construction of inner electrode prevents sudden insulation breakdown after flex crack formation.

➤ Conductive resin electrode layer absorbs external stress and protects ceramic body.

# CEU SERIES | Serial Design / X7R

Capacitance (pF)	Cap Code	CEU3 0603/C1608		CEU4 0805/C2012	
		2A (100V)	1H (50V)	2A (100V)	1H (50V)
1,000	102	■			
1,500	152				
2,200	222				
3,300	332	■			
4,700	472				
6,800	682		■		
10,000	103		■	■	
15,000	153		■	■	
22,000	223				■
33,000	333				■
47,000	473		■		■
68,000	683				■
100,000	104				■

■ X7R

# CKD SERIES | Feed Thru Capacitor

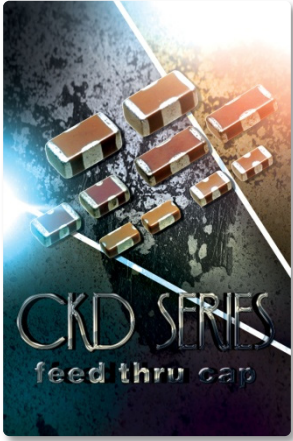

TDK Feed Through CKD series capacitors feature 3-terminal design with even lower ESL than Flip Type capacitors. Feed through design consists of 3-terminal construction where the 3rd terminal acts as a ground. Unique internal design allows for low parallel inductance and offer excellent noise reduction capability for high speed digital IC decoupling.

CKD Series are offered in a variety of case size with operating temperature range of -25°C to +85°C and -55°C to +125°C. A wide range of capacitance with rated voltage from 4V to 50V are available.

Case Code	L (mm)	W (mm)	T (mm)	B (mm)	C (mm)
CKD710JB	1.00	0.50	0.30	0.17	0.30
CKD61BJB	1.60	0.80	0.60	0.15	0.80
CKD610JB	1.60	0.80	0.80	0.10	0.40
CKD510JB	2.00	1.25	0.85	0.30	0.40
CKD110JB	3.20	1.25	0.85	0.40	0.95
CKD310JB	3.20	1.60	1.30	0.40	0.95
CKD31C10	3.20	1.60	1.30	0.40	1.20

L Body Length  
 W Body Width  
 T Body Height  
 B Terminal Width  
 C GND Terminal Width

## Part Number Description

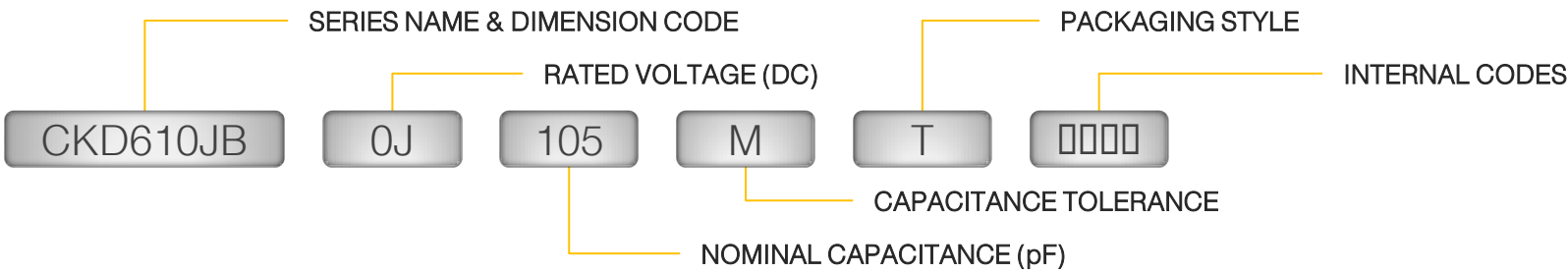

## Features:

- ❖ Ultra low inductance (less than 200 pH)
- ❖ Feed-through structure provides low ESL and high capacitance for noise elimination over a broad frequency band
- ❖ Optimized for use as noise bypass capacitor for signal and power source circuits
- ❖ Aids in EMC compliance

## Applications:

- ❖ IC power supply circuit decoupling
- ❖ High impedance/high current circuits
- ❖ DC to DC converter input/output smoothing

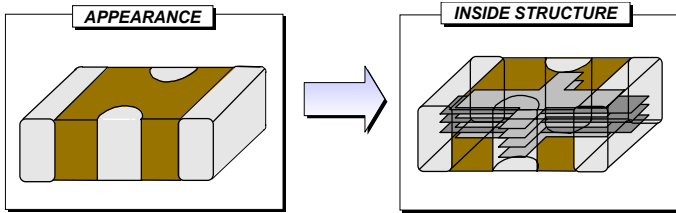

➤ Low ESL Feed Through type CKD series are constructed with 3 terminals and alternating ground and conductive layers.

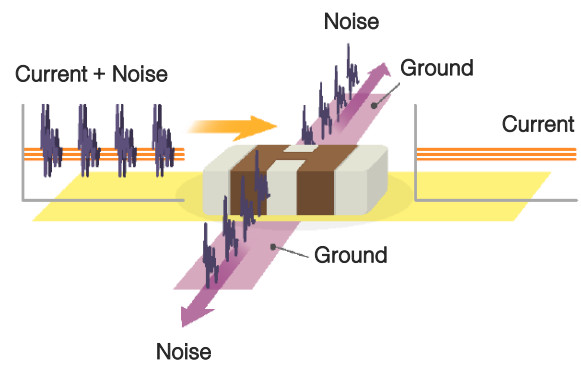
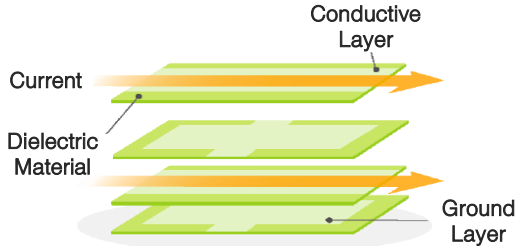

➤ When a pass-through structure is used, the smaller the distance between the capacitor and the ground, the lower the ESL. This helps reduce noise from the circuit.

# CKD SERIES | Feed Thru Capacitor

Capacitance (pF)	Cap Code	CKD710JB 0402/C1005				CKD610JB 0603/C1608		CKD61BJB 0603/C1608		CKD510JB 0805/C2012					CKD110JB 1205/C3212		CKD310JB 1206/C3216		CKD31C10 1206/C3216	
		1C (16V)	1A (10V)	0J (6.3V)	0G (4V)	1A (10V)	0J (6.3V)	1A (10V)	0J (6.3V)	1H (50V)	1E (25V)	1C (16V)	1A (10V)	0J (6.3V)	1H (50V)	1E (25V)	1C (16V)	0J (6.3V)	1H (50V)	1E (25V)
22	220									█					█					
47	470									█					█					
100	101									█					█					
220	221									█					█					
470	471									█					█					
1,000	102									█					█					
2,200	222									█					█					
4,700	472									█					█					
10,000	103									█					█					
15,000	153									█					█					
22,000	223									█					█					
47,000	473									█					█					
100,000	104	█								█					█					
220,000	224		█							█					█					
470,000	474			█						█					█					
1,000,000	105				█					█					█					
2,200,000	225					█				█					█					
4,700,000	475						█			█					█					
10,000,000	106							█		█					█					
22,000,000	226									█					█					

█ -25°C to +125°C    █ -25°C to +85°C

## Attenuation Characteristics

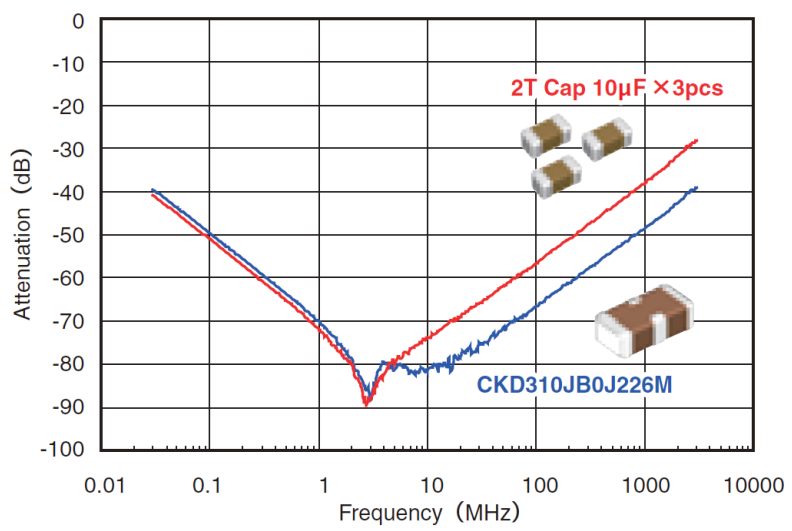

➤ It is possible to reduce the number of components with CKD Series capacitor because one CKD part has similar or better attenuation characteristics as three standard 2-terminal capacitors.

## Target Application

➤ In high-frequency application, the equivalent series resistance (ESR) and equivalent series Inductance (ESL) of a capacitor's internal electrodes and terminal electrodes become apparent. ESL acts as a hindrance, reflecting the signal current. Feed Thru Capacitor allow for better filtering and decoupling due to low ESL and ESR.

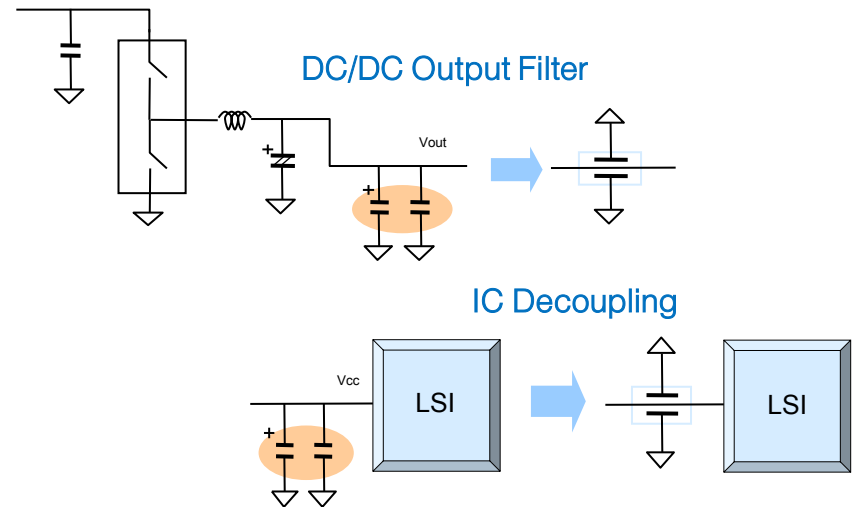

# CLL SERIES | Ultra Low Inductance



TDK's CLL multilayer ceramic capacitor series features ultra low inductance (less than 150 pH) and unique internal design. Ultra Low inductance are achieved with unique 8-terminal design. These terminals are connected in an alternating configuration which results in the cancelation of mutual inductance by alternating the flow of current so that the magnetic fields cancel each other out allowing for ultra low inductance along with reduced parasitic losses.

CLL Ultra Low Inductance series are available in two case sizes with operating temperature range of -55°C to +125°C and capacitance of up to 4.7µF. With voltage rating of 4V to 10V DC, CLL series are suitable for high speed IC decoupling as well as CPU power line decoupling. These capacitors are also effective for input/output smoothing in DC to DC converter.

Case Code	L (mm)	W (mm)	T (mm)	B (mm)	P (mm)
CLLC1A (0603)	1.60	0.80	0.50	0.40	0.25
CLLE1A (0805)	2.00	1.25	0.50	0.50	0.25
	2.00	1.25	0.85	0.50	0.25

## Part Number Description

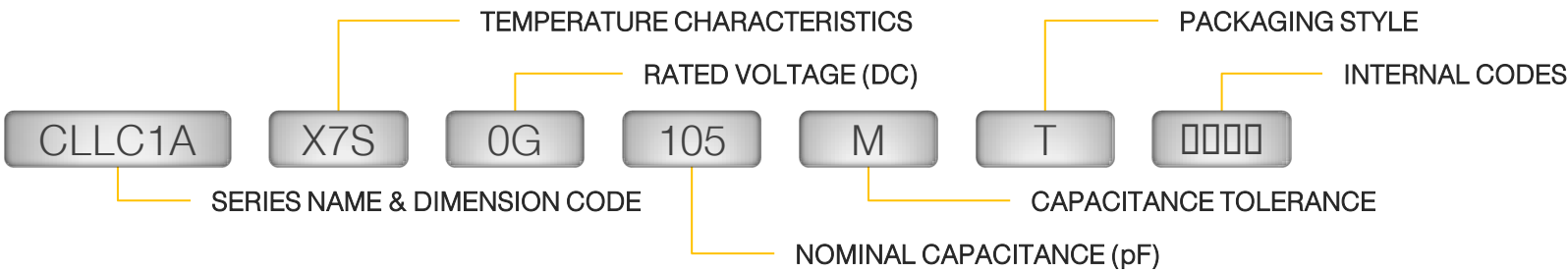

## Features:

- ❖ Unique internal structure that cancels magnetic fields to reduce inductance
- ❖ Compact and lightweight
- ❖ Contains no lead and supports lead-free soldering

## Applications:

- ❖ Decoupling CPU power line
- ❖ High speed digital IC decoupling
- ❖ High impedance/high current circuits
- ❖ DC to DC converter input/output smoothing
- ❖ Power Supply

### Unique Design of ULI Capacitor



➤ Ultra-low ESL is created by alternating the flow of current so the magnetic fields cancel out. Effective for miniaturization and achieving high capacitance.



Capacitance (pF)	Cap Code	CLLC1A 0603/C1608		CLLE1A 0805/C2012		
		0J (6.3V)	0G (4V)	1A (10V)	0J (6.3V)	0G (04V)
100,000	104					
150,000	154					
220,000	224					
330,000	334					
470,000	474					
680,000	684					
1,000,000	105					
1,500,000	155					
2,200,000	225					
4,700,000	475					

■ X7R ■ X7S

## Composition of Circuit Impedance & Target Application

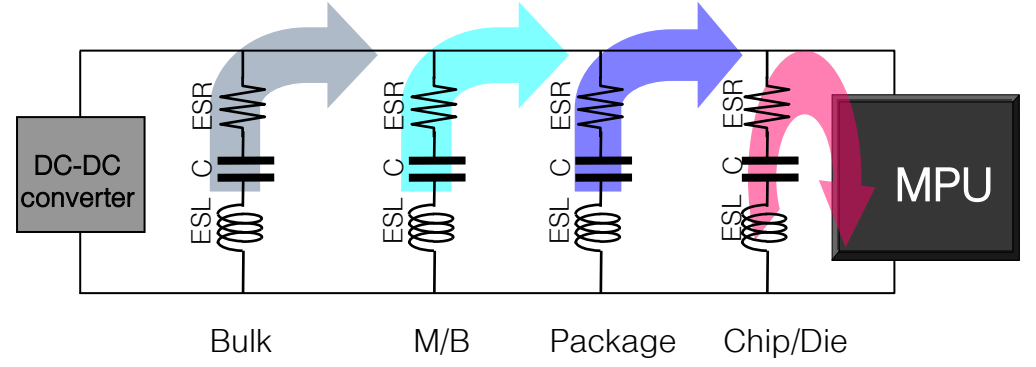
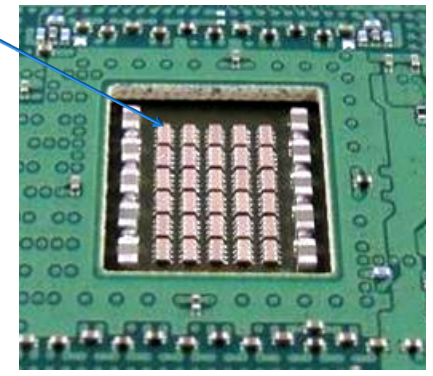
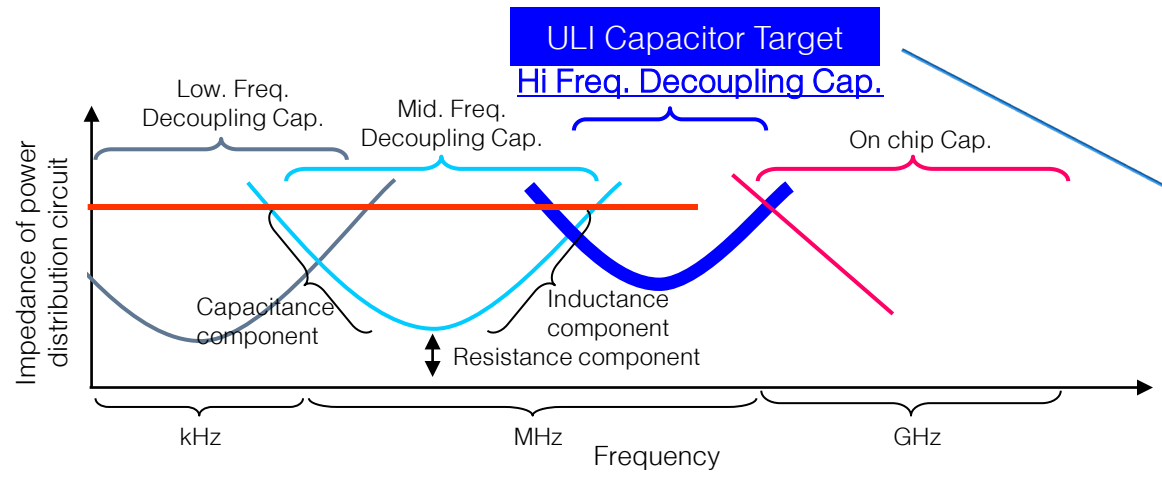



## PART NUMBER CONVERSION

This is a TDK service that assists customers in converting their existing Bill of Materials (BOM) from non-TDK to TDK part numbers. TDK has the tools and expertise to return a part number conversion request in a very short time. Some key points are:

- Quick turn-around
- Allows for downsizing and value added once converted to TDK PN
- Datasheet is provided with all available TDK PN conversion upon request
- FIT data can be provided immediately for evaluation
- MLCC alternatives to Tantalum capacitors can also be provided

## VALUE ADDED ANALYSIS

This is a TDK a service that assists customers in staying abreast of leading edge MLCCs and for TDK to offer the best component choice MLCC for pricing and delivery. "Value Added" is beneficial because it gives the following advantages to the customer:

- Downsizing / Shrinking board space
- Improved in-circuit performance capabilities
- Replacing older technologies
- Simplifying inventory control
- Improved pricing and delivery

## TANTALUM CAP REPLACEMENT

TDK offers engineering design support to assist in replacing your existing electrolytic and film capacitors with MLCCs. In order to offer best recommendations, we need to have some working knowledge of your design and circuit applications. The more you can share, the better we can offer the most cost beneficial solution options. Some information that is needed include:

- Typical and max rail voltage
- Circuit application/function
- Module function
- Design concerns/constraints
- Performance concerns/constraints
- Mechanical concerns/constraints

## TECHNICAL SUPPORT

TDK has a local MLCC manufacturing plant located in Peachtree City, Georgia, which can provide engineering and technical services.

In addition to sampling, qualification testing/reporting and problem resolution, TDK can provide component failure analysis as well. All TDK/GA failure analysis target a 3/3/7 reply policy where an initial response is given within 3 hours, the initial failure mode within 3 days, and a final report within 7 days.

TDK's MLCC boast a 0.56 ppb in market defect rate. Having manufacturing in Georgia also allows us to quickly assist you with documentation for environmental compliance such as REACH, RoHS, WEEE and others.



The TDK Technical Center, located at the TDK Georgia factory, launched in 1Q of 2012 with analysis and technical capabilities to support TDK's Multi-Layer Ceramic Capacitor products. The TTC is capable of performing electrical / mechanical evaluation and reliability testing in compliance to AEC-Q200 and MIL STD requirements. Future activities from the TTC will offer enhanced marketing tools such as teardown analysis and product demonstration as well as support request for new product development base on market demand.

## Capabilities

### ➤ Advanced Set Analysis

TDK's Technical Center has the unique ability to analyze circuits, BOM's, and applications to recommend, test, and replace electrolytic and tantalum capacitors with MLCC capacitors via circuit identification, simulation, and verification.

### ➤ Custom Testing

Our Technical Center test engineers are able to conduct and expedite a variety of electrical and mechanical tests according to your custom test standards.

- Customer Specific Testing Standards (electrical, mechanical, etc.)
- Component Characterization
- Electrical parameter characterization

### ➤ Reliability Engineering

TDK Technical Center is also heavily involved with TDK reliability engineering. We conduct a variety of testing according to strict industry, MIL-STD, and AEC-Q200 standards, some of these include: operating life test, biased humidity, destructive physical analysis, HALT testing, HAST testing, temperature cycle, burn-in, enhanced inspection, etc.

- Life Testing
- New Product Development Initiation

### ➤ Dedicated Customer Support

TDK Technical Center exhibits exceptional customer support via dedicated failure analysis services.

- Advanced Failure Analysis for High Reliability
- AEC-Q200 Approval Testing and Report

Film/TA Capacitor Replacement Analysis



Teardown Analysis & BOM optimization

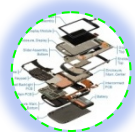

New Product Demonstration

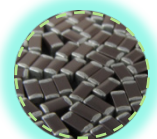

Advanced Field Failure Analysis

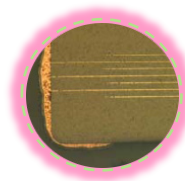

AEC Q200 PPAP Qualification Report



Design Tools Characteristic Measurements

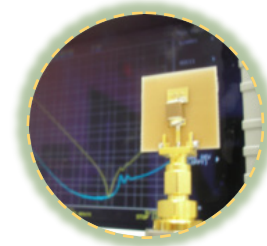

## EXCELLENT

## GOOD

## POOR

### Ceramic Capacitor

- Operating Temperature (150°C)
- Frequency Characteristics
- Ripple Current Capability
- ESR (10mΩ) / ESL (1~2nH)
- Biased Humidity (500hr)
- Reliability / Operating Life (8,000hr)
- Breakdown Voltage

- No Polarity
- Leakage Current
- Temperature Characteristics (at high frequency)
- Working Voltage (4V~3KV)
- 90% Surface Mount
- Price

- Failure Mode (Short)
- Capacitance Range (up to 100μF)
- DC Bias
- Board Flex Robustness (for large case sizes)

### Film Capacitor

- Working Voltage (35~50kV)
- DC Bias
- Temperature Characteristics
- Self Healing

- Frequency Characteristics
- Ripple Current Capacity
- ESR (40~100mΩ)
- ESL (2~3nH)
- No Polarity
- Leakage Current
- Failure Mode (Open)

- Operating Temperature (105°C)
- Reliability
- Operating Life (WV)
- Biased Humidity (WV)
- Capacitance Range (up to 100μF)
- 8% SMT

### Tantalum Capacitor

- DC Bias
- Capacitance Range (Up to 1,000μF)

- Operating Temperature (125°C)
- Frequency Characteristics
- Ripple Current Capability
- ESR (200~500mΩ) / ESL (2~6nH)
- Biased Humidity (No Voltage; 500hr)
- Reliability / Operating Life (2,000hr)
- 90% Surface Mount

- Failure Mode (Short)
- Leakage Current
- Polarity
- Working Voltage (2.5~50V)
- Price (high due to tantalum shortage)

### Aluminum Capacitor

- Price (low)
- Capacitance Range (up to 1F)
- DC Bias

- Failure Mode (Open)
- Operating Life (1,000hr)
- Biased Humidity (No Voltage; 500hr)
- Reliability
- Working Voltage (4~500V)

- Operating Temperature (105°C)
- Frequency Characteristics
- Ripple Current Capability
- ESR (1000mΩ) / ESL (4~10nH)
- Polarity
- Leakage Current
- 10% Surface Mount



# ELECTROLYTIC CAP REPLACEMENT

## Electrolytic Capacitor Replacement Overview:

- ❖ Select electrolytic capacitors can be replaced with MLCC without sacrificing quality or performance
- ❖ TDK can work with our customers to study the electrolytic capacitors used in their designs
- ❖ The primary focus is on decoupling and smoothing capacitors for noise suppression
- ❖ Other circuit applications such as bulk capacitance are also studied if applicable
- ❖ By measuring initial performance, TDK can recommend alternative MLCC's

## Electrolytic Capacitor Replacement Benefits:

- ❖ Worldwide shortage of Ta caps has generated interest by many companies
- ❖ MLCC's offer a technological advantage as well as a more robust design
- ❖ In some cases, electrolytic cap replacement can result in reduced component count
- ❖ Use of MLCC's will reduce space usage on PCB and cost of components & lower cost of assembly
- ❖ Lower inherent ESR & increased reliability

Determine the maximum working line voltage (use the chart below as a guide)

Step 1

Working Voltage	Rated Voltage	Voltage Code
3 ~ 5V	6.3V	0J
8 ~ 9V	10V	1A
12 ~ 15V	16V	1C
18 ~ 20V	25V	1E

\* MLCC's do not have voltage de-rating rule so you can use up to the full rated voltage

Determine the circuit's function and replace at the minimum acceptable cap value

Step 2

Application	Capacitance Guidepost	
For Decoupling/ Smoothing	Ta Cap, Aluminum Electrolytic Caps	~20%
	Organic Semiconductor	~50%
For Time Constance/ Coupling	Ta Cap, Aluminum Electrolytic Caps	~100%
	Organic Semiconductor	~100%

\*Based on circuit function, MLCC cap value may not need to be a 100% replacement

Step 3 Base on application, identify the suggested MLCC replacement part number by referencing your current TA/ALU capacitance and current working voltage (WV)

Smoothing/By-Passing: ≤ 100kHz		WV ≤ 6.3V	WV ≤ 10V	WV ≤ 16V	WV ≤ 25V	WV ≤ 35V	WV ≤ 50V	WV ≤ 100V	WV ≤ 250V	
ALUMINUM ELECTROLYTIC/ TANTALUM CAPACITORS	CAPACITANCE OF TA/ALU CAP	0.1µF	C0603X5R0J473K	C1005X7R1A473K	C1005X7R1C473K	C1005X7R1E473K	C1005X7R1V473K	C1005X7R1H473K	C1608X7S2A473K	C2012X7T2E473K
		0.22µF	C1005X5R0J104K	C1005X7R1A104K	C1005X7R1C104K	C1005X7R1E104K	C1005X7R1V104K	C1005X7R1H104K	C1608X7S2A104K	C2012X7T2E104K
		0.47µF	C1005X5R0J224K	C1005X7R1A224K	C1005X7R1C224K	C1005X6S1E224K	C1608X6S1V224K	C1608X7R1H224K	C2012X7S2A224K	C3216X7T2E224K
		1.0µF	C1005X6S0J474K	C1005X5R1A474K	C1608X7R1C474K	C1608X7R1E474K	C1608X7R1V474K	C1608X7R1H474K	C2012X7S2A474K	C4532X7R2E474K
		2.2µF	C1005X6S0J105K	C1005X5R1A105K	C1608X7R1C105K	C1608X7R1E105K	C1608X7R1V105K	C1608X6S1H105K	C2012X7S2A105K	C4532X7T2E105K
		4.7µF	C1005X5R0J225K	C1005X5R1A225K	C1608X6S1C225K	C2012X7R1E225K	C2012X7R1V225K	C2012X7R1H225K	C3216X7S2A225K	C5750X7T2E225K
		10µF	C1005X5R0J475K	C1608X6S1A475K	C2012X7R1C475K	C2012X7R1E475K	C2012X7R1V475K	C2012X6S1H475K	C3225X7S2A475K	-
		22µF	C1608X5R0J106K	C1608X5R1A106K	C2012X6S1C106K	C3216X7R1E106K	C3216X7R1V106M	C3225X7S1H106K	C5750X7S2A106M	-
		47µF	C2012X6S0J226K	C2012X6S1A226K	C2012X5R1C226K	C3216X5R1E226M	C3216X5R1V226M	CKG57NX7S1H226M	CKG57NX7S2A226M	-
		100µF	C2012X5R0J476M	C3216X6S1A476M	C3216X5R1C476M	C3216X5R1E476M	-	-	-	-
220µF	C3216X5R0J107M	C3216X5R1A107M	CKG57NX7S1C107M	-	-	-	-	-		
Coupling/Time Constant: ≤ 100kHz		WV ≤ 6.3V	WV ≤ 10V	WV ≤ 16V	WV ≤ 25V	WV ≤ 35V	WV ≤ 50V	WV ≤ 100V	WV ≤ 250V	
ALUMINUM ELECTROLYTIC/ TANTALUM CAPACITORS	CAPACITANCE OF TA/ALU CAP	0.1µF	C1005X5R0J104K	C1005X7R1A104K	C1005X7R1C104K	C1005X7R1E104K	C1005X7R1V104K	C1005X7R1H104K	C1608X7S2A104K	C2012X7T2E104K
		0.22µF	C1005X5R0J224K	C1005X7R1A224K	C1005X7R1C224K	C1005X6S1E224K	C1608X6S1V224K	C1608X7R1H224K	C2012X7S2A224K	C3216X7T2E224K
		0.47µF	C1005X6S0J474K	C1005X5R1A474K	C1608X7R1C474K	C1608X7R1E474K	C1608X7R1V474K	C1608X7R1H474K	C2012X7S2A474K	C4532X7R2E474K
		1.0µF	C1005X6S0J105K	C1005X5R1A105K	C1608X7R1C105K	C1608X7R1E105K	C1608X7R1V105K	C1608X6S1H105K	C2012X7S2A105K	C4532X7T2E105K
		2.2µF	C1005X5R0J225K	C1005X5R1A225K	C1608X6S1C225K	C2012X7R1E225K	C2012X7R1V225K	C2012X7R1H225K	C3216X7S2A225K	C5750X7T2E225K
		4.7µF	C1005X5R0J475K	C1608X6S1A475K	C2012X7R1C475K	C2012X7R1E475K	C2012X7R1V475K	C2012X6S1H475K	C3225X7S2A475K	-
		10µF	C1608X5R0J106K	C1608X5R1A106K	C2012X6S1C106K	C3216X7R1E106K	C3216X7R1V106M	C3225X7S1H106K	C5750X7S2A106M	-
		22µF	C2012X6S0J226K	C2012X6S1A226K	C2012X5R1C226K	C3216X5R1E226M	C3216X5R1V226M	CKG57NX7S1H226M	CKG57NX7S2A226M	-
		47µF	C2012X5R0J476M	C3216X6S1A476M	C3216X5R1C476M	C3216X5R1E476M	-	-	-	-
		100µF	C3216X5R0J107M	C3216X5R1A107M	CKG57NX7S1C107M	-	-	-	-	-

# E-SERIES REFERENCE GUIDE

## What is E-Series?

- ❖ The E-Series is an EIA-5101 standard used by the industry to determine steps for capacitor and resistor values
- ❖ The E-Series is a geometric progression obtained by using a numeric base value

## Example:

- ❖ E-3 has 3 numbers and it's base value is  $3\sqrt[3]{10} = 2.2$
- ❖ The E-3 series capacitance steps are taken from the base values as follows: 2.2<sup>0</sup>, 2.2<sup>1</sup>, and 2.2<sup>2</sup>
- ❖ Therefore, an E-3 series offering would include the following values: 100pF; 220pF; 470pF; 1,000pF; 2,200pF; 4,700, etc.

E-Series	Capacitance Steps											
E-1	1.0											
E-3	1.0				2.2				4.7			
E-6	1.0	1.5	2.2	3.3	4.7	6.8						
E-12	1.0	1.2	1.5	1.8	2.2	2.7	3.3	3.9	4.7	5.6	6.8	8.2

\* TDK offers C0G as E-12, X7R/X5R as E-6, X7S/X6S as E-3 and Y5V as E-1

Cap Code	E-Series				pF	nF	μF
	1	3	6	12			
R12			✖		0.12	0.00012	0.00000012
R15			✖	✖	0.15	0.00015	0.00000015
R18				✖	0.18	0.00018	0.00000018
R22		✖	✖	✖	0.22	0.00022	0.00000022
R27				✖	0.27	0.00027	0.00000027
R33			✖	✖	0.33	0.00033	0.00000033
R39				✖	0.39	0.00039	0.00000039
R47		✖	✖	✖	0.47	0.00047	0.00000047
R56				✖	0.56	0.00056	0.00000056
R68				✖	0.68	0.00068	0.00000068
R82				✖	0.82	0.00082	0.00000082
010	✖	✖	✖	✖	1	0.001	0.000001
1R2				✖	1.2	0.0012	0.0000012
1R5				✖	1.5	0.0015	0.0000015
1R8				✖	1.8	0.0018	0.0000018
2R2		✖	✖	✖	2.2	0.0022	0.0000022
2R7				✖	2.7	0.0027	0.0000027
3R3				✖	3.3	0.0033	0.0000033
3R9				✖	3.9	0.0039	0.0000039
4R7		✖	✖	✖	4.7	0.0047	0.0000047
5R6				✖	5.6	0.0056	0.0000056
6R8				✖	6.8	0.0068	0.0000068
8R2				✖	8.2	0.0082	0.0000082
100	✖	✖	✖	✖	10	0.010	0.000010
120				✖	12	0.012	0.000012
150				✖	15	0.015	0.000015
180				✖	18	0.018	0.000018
220		✖	✖	✖	22	0.022	0.000022
270				✖	27	0.027	0.000027
330				✖	33	0.033	0.000033
390				✖	39	0.039	0.000039
470		✖	✖	✖	47	0.047	0.000047
560				✖	56	0.056	0.000056
680				✖	68	0.068	0.000068
820				✖	82	0.082	0.000082
101	✖	✖	✖	✖	100	0.10	0.00010

Cap Code	E-Series				pF	nF	μF
	1	3	6	12			
121				✖	120	0.12	0.00012
151			✖	✖	150	0.15	0.00015
181				✖	180	0.18	0.00018
221		✖	✖	✖	220	0.22	0.00022
271				✖	270	0.27	0.00027
331			✖	✖	330	0.33	0.00033
391				✖	390	0.39	0.00039
471		✖	✖	✖	470	0.47	0.00047
561				✖	560	0.56	0.00056
681				✖	680	0.68	0.00068
821				✖	820	0.82	0.00082
102	✖	✖	✖	✖	1,000	1	0.0010
122				✖	1,200	1.2	0.0012
152				✖	1,500	1.5	0.0015
182				✖	1,800	1.8	0.0018
222		✖	✖	✖	2,200	2.2	0.0022
272				✖	2,700	2.7	0.0027
332				✖	3,300	3.3	0.0033
392				✖	3,900	3.9	0.0039
472		✖	✖	✖	4,700	4.7	0.0047
562				✖	5,600	5.6	0.0056
682				✖	6,800	6.8	0.0068
822				✖	8,200	8.2	0.0082
103	✖	✖	✖	✖	10,000	10	0.010
123				✖	12,000	12	0.012
153				✖	15,000	15	0.015
183				✖	18,000	18	0.018
223		✖	✖	✖	22,000	22	0.022
273				✖	27,000	27	0.027
333				✖	33,000	33	0.033
393				✖	39,000	39	0.039
473		✖	✖	✖	47,000	47	0.047
563				✖	56,000	56	0.056
683				✖	68,000	68	0.068
823				✖	82,000	82	0.082
104	✖	✖	✖	✖	100,000	100	0.10

Cap Code	E-Series				pF	nF	μF
	1	3	6	12			
124				✖	120,000	120	0.12
154			✖	✖	150,000	150	0.15
184				✖	180,000	180	0.18
224		✖	✖	✖	220,000	220	0.22
274				✖	270,000	270	0.27
334				✖	330,000	330	0.33
394				✖	390,000	390	0.39
474		✖	✖	✖	470,000	470	0.47
564				✖	560,000	560	0.56
684				✖	680,000	680	0.68
824				✖	820,000	820	0.82
105	✖	✖	✖	✖	1,000,000	1,000	1
125				✖	1,200,000	1,200	1.2
155				✖	1,500,000	1,500	1.5
185				✖	1,800,000	1,800	1.8
225		✖	✖	✖	2,200,000	2,200	2.2
275				✖	2,700,000	2,700	2.7
335				✖	3,300,000	3,300	3.3
395				✖	3,900,000	3,900	3.9
475		✖	✖	✖	4,700,000	4,700	4.7
565				✖	5,600,000	5,600	5.6
685				✖	6,800,000	6,800	6.8
825				✖	8,200,000	8,200	8.2
106	✖	✖	✖	✖	10,000,000	10,000	10
126				✖	12,000,000	12,000	12
156				✖	15,000,000	15,000	15
186				✖	18,000,000	18,000	18
226		✖	✖	✖	22,000,000	22,000	22
276				✖	27,000,000	27,000	27
336				✖	33,000,000	33,000	33
396				✖	39,000,000	39,000	39
476		✖	✖	✖	47,000,000	47,000	47
566				✖	56,000,000	56,000	56
686				✖	68,000,000	68,000	68
826				✖	82,000,000	82,000	82
107	✖	✖	✖	✖	100,000,000	100,000	100

## Available Application Notes

## Synopsis/Summary

FAQ Electrical, ESD Application Note.	Electrostatic discharge facts and product selection considerations and recommendations
FAQ Electrical, ESR Modeling	ESR Equivalent Series Resistance facts and measurement instructions
FAQ Electrical, ESR Performance with Temperature	ESR performance with a focus on the effects of temperature, includes both external and internal effects
FAQ Electrical, High Capacitance Measurement	Measurement Tips for High Capacitance MLCC's
FAQ Electrical, How should I measure capacitors?	Fundamentals for measuring capacitance, dissipation factor, quality factor, and insulation resistance
FAQ Electrical, How should I measure SRF?	Fundamentals and meter settings for measuring self-resonance frequency (SRF) for low capacitance capacitors
FAQ Electrical, HP4291 RF Impedance Analyzer	Measurement instructions, accuracy, calibration of the HP4291 RF/Impedance Analyzer
FAQ Electrical, MLCC Ripple Current	Power dissipation capability matching and Ripple Current fundamentals
FAQ Electrical, Singing Capacitors (Piezoelectric Effect)	Certain MLCCs sometimes exhibit a phenomena described as "singing" and is actually a piezoelectric effect consisting of a vibration or low audible hum. This FAQ will discuss some aspects of this behavior
FAQ Mechanical, SMT Rework, Solder Conditions	Tips and tricks for MLCC rework methods
FAQ Mechanical, Terminal Adhesion	Q&A regarding soldering and adhesion of MLCC to PCB
FAQ Mechanical, Tombstoning	Model of Chip Cap Tombstoning
FAQ Other, Buyer Beware (Counterfeit)	Frequently asked questions regarding the increasing trend of counterfeit electronic components.
FAQ Other, Environmental	Information regarding the constituents of a MLCC and company environmental position
FAQ Other, MLCC Qualification Guide	Commonly asked questions concerning family approvals and the associated test batteries for MLCCs
FAQ Other, Qualification Statement (Q200 Compliance)	Statement regarding TDK MLCC qualification compliance to EIA 198 and CDF-AEC-Q200 standards as well as "automotive" vs. "non-automotive" grades.
FAQ Other, Sn Whisker	Guide to manufacturing techniques to reduce the risk of tin whisker formation
FAQ Other, TDK MLCC FIT Calculations	Frequently asked questions regarding TDK's Failure in Time calculations and Mean Time To Failure / Mean Time Between Failure for capacitors
FAQ Other, TDK MLCC Test Standards	TDK test methods for performance of MLCC defined
FAQ Other, TDK PPAP	PPAP fundamentals
FAQ Other, TDK Standard vs Unique/AUTO Grade MLCCs	Frequently asked questions regarding the difference between TDK's standard grade and unique grade MLCCs
FAQ Other, Value Added	Q&A for performing Value Added analysis to reduce board space and cut cost while keeping performance capabilities
FAQ, Understanding the E-Series	Explanations of E-Series
FAQ, What is the Cap of this Cap?	Fundamentals regarding capacitor aging and its effect on capacitance
FAQ, Common Cracking Modes	Introduction to various cracking modes commonly exhibited by MLCCs
FAQ, Open Mode Capacitor and the 1210 rule	Frequently asked questions regarding TDK's inner electrode design which reduce the risk of electrical short in the event of a board flex crack
FAQ, TDK's Modeling Tools (SEATS and CCV)	Comparison for two of TDK's modeling tools

\* Please contact your TDK Sales Representation for more information on how to obtain these application notes

## Components Characteristics Viewer

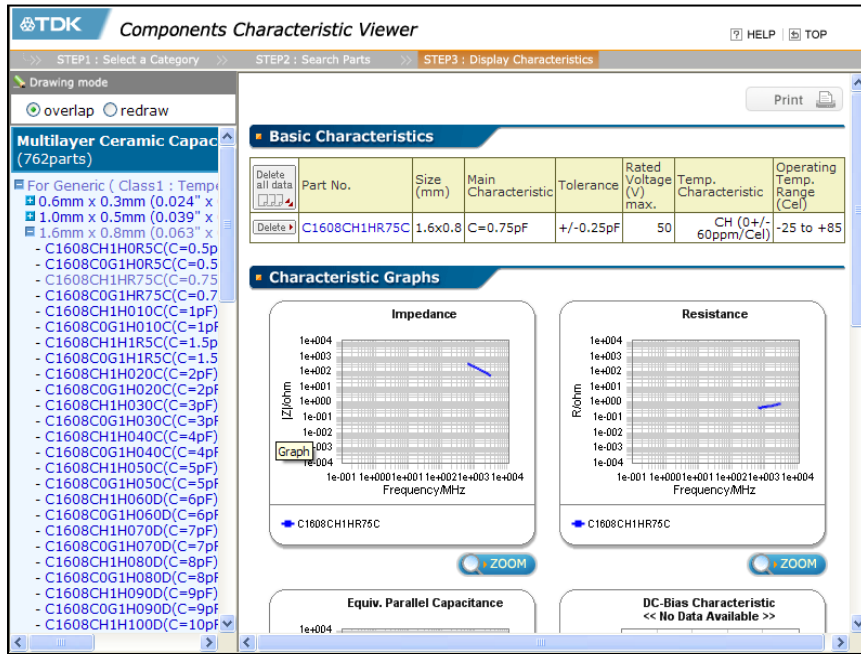

TDK's Components Characteristic Viewer (CCV) tool provides you with a simple online procedure for checking the basic, frequency, DC-Bias and temperature characteristics of TDK electronic parts. You can use it as a tool for selecting TDK electronic part. Both CCV and SEATs offer a wide array of data available that can be modeled either online, but SEATs must be downloaded for use as a desktop application program. CCV is a web-based tool that can be used with available access to the internet. This is one of the main differences between CCV and SEATs.

## Features

- ✓ 2-port parts can display a maximum of 27 kinds of frequency characteristics, and 4-port parts can display a maximum of 70 kinds.
- ✓ DC-Bias and temperature characteristics of inductors and capacitors can be displayed.
- ✓ It is possible to set an axis or change the reference impedance of the S parameter in the frequency characteristic. It is also possible to download data.
- ✓ Frequency characteristics can be overwritten, so it is easy to compare parts.
- ✓ Parts lists use a tree view display, to make it easy to search for or select parts.
- ✓ The tool is linked to electronic part catalog data in compliance with JEITA, so it can display more detailed data.
- ✓ Approximately 3300 parts are recorded at present (including ferrite beads, inductors, capacitors, 3-terminal filters, common mode filters and varistors).

➤ For more information, please visit <http://www.tdk.co.jp/ccv/index.asp>

## TDK Virtual Component Library (TVCL)

TDK Virtual Components Library is a collection of equivalent circuit models compatible with various circuit simulators available on TDK's official website. Circuit simulations using the actual characteristics of TDK's electronic components can easily be performed. TVCL features an extensive number of products (more than 3,000 products) and are compatible with major circuit simulators. Equivalent circuit models take into account component structures and material characteristics allow for detailed models of actual components characteristics.

Compatible Simulators	Available TDK Components								
	MLCC	Inductors			Ferrite Beads	3-Term Filters	Common Mode Filter	Pulse XFormer	Varistors
		RF	Signal	Power					
SPICE Net List	✖	✖	✖	✖	✖	✖	✖	✖	-
Agilent ADS	✖	✖	✖	✖	✖	✖	✖	✖	✖
Ansoft Designer®	✖	✖	✖	✖	✖	✖	✖	✖	✖
Ansoft NEXXIM®	✖	✖	✖	✖	✖	✖	✖	✖	✖
AWR Microwave Office	✖	✖	✖	-	✖	-	✖	-	✖
Cadence Allegro® PCB PI	✖	-	-	-	✖	-	✖	-	-
Cadence Allegro® PCB SI	✖	-	-	-	✖	-	✖	-	-
Suken CR-5000 Lightning	-	-	-	-	-	-	✖	-	-

## Comparison of Equivalent Circuit Models and Actual Measurements

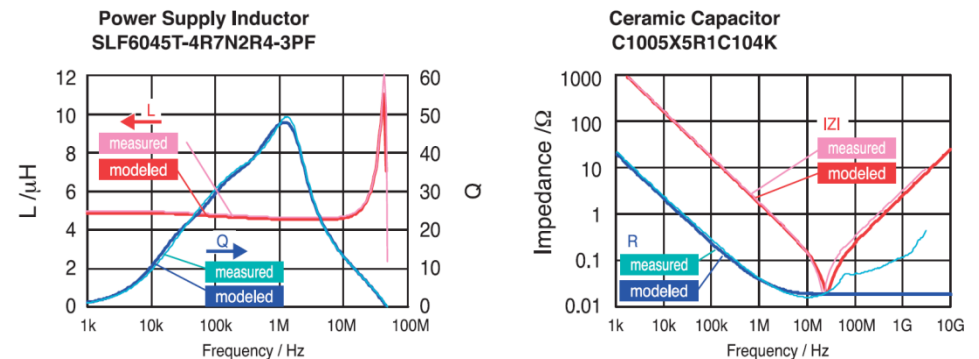

➤ For more information, please visit <http://www.tdk.com/tvcl.php>



## Selection Assistant of TDK Components

SEAT stands for SElection Assistant of TDK components. SEAT makes it easy to simulate the characteristics of components including inductors, capacitors, common mode filters, and varistors. This not only reduces design and development time, but also provides substantial support when searching for optimal components for EMC and power supply use.

With SEAT, various kinds of impedance and S-parameters can be displayed. Impedance characteristics such as magnitude value, phase, admittance, inductance, capacitance,  $\tan\delta$ , and Q can be displayed. S-parameters such as magnitude value, phase, group delay time, Smith chart, and VSWR can be displayed. Mixed mode S-parameters, which are essential for analyzing balanced components, can also be handled. In addition, it is possible to display the temperature-resistance characteristics of NTC thermistors, and the voltage-current characteristics of chip varistors.

## Capabilities

- ✓ Pulse Response Simulation (Single Lines and Differential Lines)
  - This simulation can show the influence on waveforms when a component is used on a digital circuit.
- ✓ TDR Simulation
  - This simulation shows the characteristic impedance of components.
- ✓ NTC Thermistor Simulation
  - This simulation can show the output voltage when a NTC thermistor is installed on a circuit.
- ✓ Inductor's Characteristic Simulation
  - This simulation shows the DC bias characteristics, temperature characteristics, and temperature rise characteristics caused by current flow.
- ✓ Capacitor's Characteristic Simulation
  - This simulation shows the DC bias characteristics, temperature characteristics, and temperature rise characteristics caused by current flow.

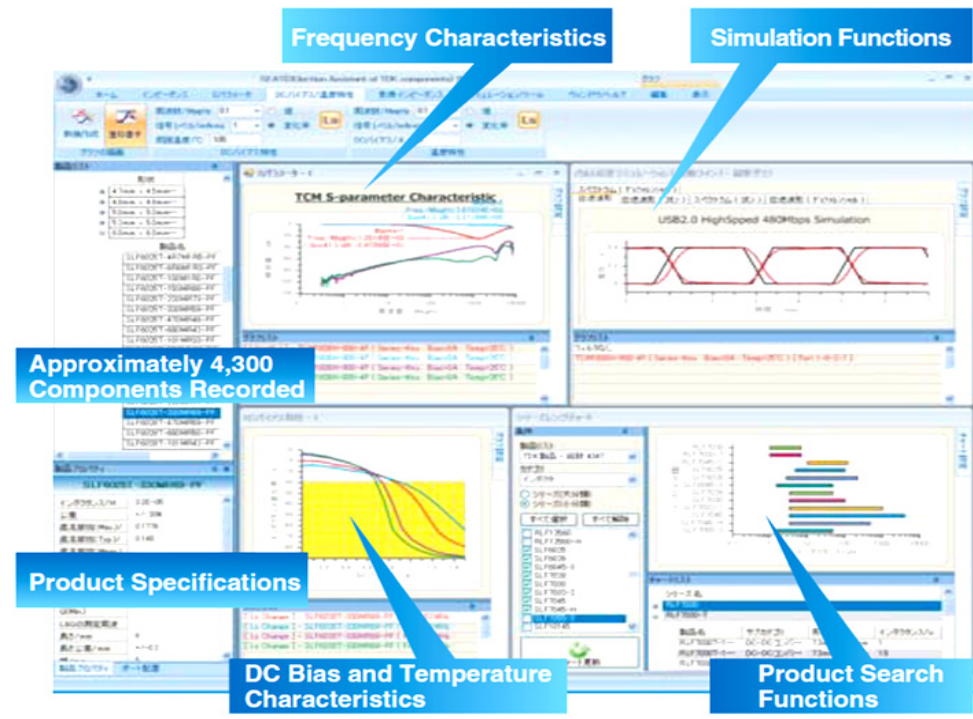

## Features

- ✓ Over 4,000 Components are Included in the database including coils, capacitors, inductors, beads, three-terminal filters, common mode filters, varistors, NTC thermistors, baluns, etc...
- ✓ Display frequency characteristics including impedance and S Parameters (including mix mode)
- ✓ Display DC bias and temperature characteristics
- ✓ Pulse Response Simulation (Single end/differential transmission)
- ✓ TDR Simulation (Assessment of component characteristic impedance)
- ✓ Temperature increase simulation (Temperature increase from inductor direct current and capacitor ripple)
- ✓ User-Defined Filter
- ✓ Characteristic Impedance Calculator (Characteristic impedance can be calculated from circuit board dimensions (also compatible with coupled lines))
- ✓ Product search function
- ✓ Support automatic online updates (Only modified portions are downloaded from the Internet to update the software to the latest version)

## Supports Automatic Online Updates



➤ For more information, please visit <http://www.tdk.co.jp/ccv/index.asp>

TDK Part Number (Ordering Code)	Case Size	T.C. Code	Voltage (DC)	Cap (pF)	Cap Tolerance
C0603X5R0G105M	0201	X5R	4	1,000,000	+/-20%
C0402X5R0G104K	01005	X5R	4	100,000	+/-10%
C0402X5R0G104M	01005	X5R	4	100,000	+/-20%
C2012X7R1C475K/SOFT	0805	X7R	16	4,700,000	+/-10%
C2012X7R1V225K/SOFT	0805	X7R	35	2,200,000	+/-10%
C2012X7R1H474K/SOFT	0805	X7R	50	470,000	+/-10%
C2012X7R1H105K/SOFT	0805	X7R	50	1,000,000	+/-10%
C2012X7S2A224K/SOFT	0805	X7S	100	220,000	+/-10%
C2012X7S2A474K/SOFT	0805	X7S	100	470,000	+/-10%
C2012X7S2A105K/SOFT	0805	X7S	100	1,000,000	+/-10%
C2012X7R2E103K/SOFT	0805	X7R	250	10,000	+/-10%
C2012X7R2E223K/SOFT	0805	X7R	250	22,000	+/-10%
C2012X7T2E473K/SOFT	0805	X7T	250	47,000	+/-10%
C2012X7T2E104K/SOFT	0805	X7T	250	100,000	+/-10%
C2012X7T2W103K/SOFT	0805	X7T	450	10,000	+/-10%
C2012X7T2W223K/SOFT	0805	X7T	450	22,000	+/-10%
C2012X7T2W473K/SOFT	0805	X7T	450	47,000	+/-10%
C3216X7R1E106K/SOFT	1206	X7R	25	10,000,000	+/-10%
C3216X7R1V475K/SOFT	1206	X7R	35	4,700,000	+/-10%
C3216X7R1H105K/SOFT	1206	X7R	50	1,000,000	+/-10%
C3216X7R1H225K/SOFT	1206	X7R	50	2,200,000	+/-10%
C3216X7R2A474K/SOFT	1206	X7R	100	470,000	+/-10%
C3216X7R2A105K/SOFT	1206	X7R	100	1,000,000	+/-10%
C3216X7S2A225K/SOFT	1206	X7S	100	2,200,000	+/-10%
C3216X7R2E104K/SOFT	1206	X7R	250	100,000	+/-10%
C3216X7T2E224K/SOFT	1206	X7T	250	220,000	+/-10%
C3216X7T2W104K/SOFT	1206	X7T	450	100,000	+/-10%
C3216X7R2J103K/SOFT	1206	X7R	630	10,000	+/-10%
C3216X7R2J223K/SOFT	1206	X7R	630	22,000	+/-10%
C3216X7T2J473K/SOFT	1206	X7T	630	47,000	+/-10%
C3225X7S1H475K/SOFT	1210	X7S	50	4,700,000	+/-10%
C3225X7S1H106K/SOFT	1210	X7S	50	10,000,000	+/-10%
C3225X7R2A225K/SOFT	1210	X7R	100	2,200,000	+/-10%
C3225X7S2A475K/SOFT	1210	X7S	100	4,700,000	+/-10%
C3225X7R2E104K/SOFT	1210	X7R	250	100,000	+/-10%
C3225X7R2E224K/SOFT	1210	X7R	250	220,000	+/-10%
C3225X7T2W224K/SOFT	1210	X7T	450	220,000	+/-10%
C3225X7R2J473K/SOFT	1210	X7R	630	47,000	+/-10%
C3225X7T2J104K/SOFT	1210	X7T	630	100,000	+/-10%
C4532X7R2E474K/SOFT	1812	X7R	250	470,000	+/-10%
C4532X7T2E105K/SOFT	1812	X7T	250	1,000,000	+/-10%
C4532X7T2W474K/SOFT	1812	X7T	450	470,000	+/-10%
C4532X7T2J224K/SOFT	1812	X7T	630	220,000	+/-10%
C5750X7S2A106K/SOFT	2220	X7S	100	10,000,000	+/-10%
C5750X7R2E105K/SOFT	2220	X7R	250	1,000,000	+/-10%
C5750X7T2E225K/SOFT	2220	X7T	250	2,200,000	+/-10%
C5750X7T2W105K/SOFT	2220	X7T	450	1,000,000	+/-10%
C5750X7T2J474K/SOFT	2220	X7T	630	470,000	+/-10%
CGA4J3X7R1C475K/SOFT	0805	X7R	16	4,700,000	+/-10%
CGA4J1X7R1V225K/SOFT	0805	X7R	35	2,200,000	+/-10%

TDK Part Number (Ordering Code)	Case Size	T.C. Code	Voltage (DC)	Cap (pF)	Cap Tolerance
CGA4J3X7R1H474K/SOFT	0805	X7R	50	470,000	+/-10%
CGA4J3X7R1H105K/SOFT	0805	X7R	50	1,000,000	+/-10%
CGA4F3X7S2A224K/SOFT	0805	X7S	100	220,000	+/-10%
CGA4J3X7S2A474K/SOFT	0805	X7S	100	470,000	+/-10%
CGA4J3X7S2A105K/SOFT	0805	X7S	100	1,000,000	+/-10%
CGA4J3X7R2E103K/SOFT	0805	X7R	250	10,000	+/-10%
CGA4J3X7R2E223K/SOFT	0805	X7R	250	22,000	+/-10%
CGA4J3X7T2E473K/SOFT	0805	X7T	250	47,000	+/-10%
CGA4J3X7T2E104K/SOFT	0805	X7T	250	100,000	+/-10%
CGA4F4X7T2W103K/SOFT	0805	X7T	450	10,000	+/-10%
CGA4J4X7T2W223K/SOFT	0805	X7T	450	22,000	+/-10%
CGA4J4X7T2W473K/SOFT	0805	X7T	450	47,000	+/-10%
CGA5L1X7R1E106K/SOFT	1206	X7R	25	10,000,000	+/-10%
CGA5L1X7R1V475K/SOFT	1206	X7R	35	4,700,000	+/-10%
CGA5L3X7R1H105K/SOFT	1206	X7R	50	1,000,000	+/-10%
CGA5L3X7R1H225K/SOFT	1206	X7R	50	2,200,000	+/-10%
CGA5L2X7R2A474K/SOFT	1206	X7R	100	470,000	+/-10%
CGA5L2X7R2A105K/SOFT	1206	X7R	100	1,000,000	+/-10%
CGA5L3X7S2A225K/SOFT	1206	X7S	100	2,200,000	+/-10%
CGA5L3X7R2E104K/SOFT	1206	X7R	250	100,000	+/-10%
CGA5L3X7T2E224K/SOFT	1206	X7T	250	220,000	+/-10%
CGA5L4X7T2W104K/SOFT	1206	X7T	450	100,000	+/-10%
CGA5H4X7R2J103K/SOFT	1206	X7R	630	10,000	+/-10%
CGA5K4X7R2J223K/SOFT	1206	X7R	630	22,000	+/-10%
CGA5L1X7T2J473K/SOFT	1206	X7T	630	47,000	+/-10%
CGA6N3X7S1H475K/SOFT	1210	X7S	50	4,700,000	+/-10%
CGA6P3X7S1H106K/SOFT	1210	X7S	50	10,000,000	+/-10%
CGA6N3X7R2A225K/SOFT	1210	X7R	100	2,200,000	+/-10%
CGA6M3X7S2A475K/SOFT	1210	X7S	100	4,700,000	+/-10%
CGA6M3X7R2E104K/SOFT	1210	X7R	250	100,000	+/-10%
CGA6M3X7R2E224K/SOFT	1210	X7R	250	220,000	+/-10%
CGA6M4X7T2W224K/SOFT	1210	X7T	450	220,000	+/-10%
CGA6M4X7R2J473K/SOFT	1210	X7R	630	47,000	+/-10%
CGA6L1X7T2J104K/SOFT	1210	X7T	630	100,000	+/-10%
CGA8N3X7R2E474K/SOFT	1812	X7R	250	470,000	+/-10%
CGA8P3X7T2E105K/SOFT	1812	X7T	250	1,000,000	+/-10%
CGA8N4X7T2W474K/SOFT	1812	X7T	450	470,000	+/-10%
CGA8M1X7T2J224K/SOFT	1812	X7T	630	220,000	+/-10%
CGA9N3X7S2A106K/SOFT	2220	X7S	100	10,000,000	+/-10%
CGA9N3X7R2E105K/SOFT	2220	X7R	250	1,000,000	+/-10%
CGA9P3X7T2E225K/SOFT	2220	X7T	250	2,200,000	+/-10%
CGA9P4X7T2W105K/SOFT	2220	X7T	450	1,000,000	+/-10%
CGA9P1X7T2J474K/SOFT	2220	X7T	630	470,000	+/-10%
C7563X7S1H226M/SOFT	3025	X7S	50	22,000,000	+/-20%
C7563X7S1C107M/SOFT	3025	X7S	16	100,000,000	+/-20%
C1632X7R1A225M	0612	X7R	10	2,200,000	+/-20%
C1005X8R1H682K	0402	X8R	50	6,800	+/-10%
C1005X8R1H103K	0402	X8R	50	10,000	+/-10%
C1005X8R1E153K	0402	X8R	25	15,000	+/-10%
C1005X8R1E223K	0402	X8R	25	22,000	+/-10%

TDK Part Number (Ordering Code)	Case Size	T.C. Code	Voltage (DC)	Cap (pF)	Cap Tolerance
C1005X8R1C333K	0402	X8R	16	33,000	+/-10%
C1005X8R1C473K	0402	X8R	16	47,000	+/-10%
C1608X8R1H683K	0603	X8R	50	68,000	+/-10%
C1608X8R1H104K	0603	X8R	50	100,000	+/-10%
C1608X8R1E154K	0603	X8R	25	150,000	+/-10%
C1608X8R1E224K	0603	X8R	25	220,000	+/-10%
C1608X8R1C334K	0603	X8R	16	330,000	+/-10%
C1608X8R1C474K	0603	X8R	16	470,000	+/-10%
C2012X8R1H154K	0805	X8R	50	150,000	+/-10%
C2012X8R1H224K	0805	X8R	50	220,000	+/-10%
C2012X8R1E474K	0805	X8R	25	470,000	+/-10%
C2012X8R1C684K	0805	X8R	16	680,000	+/-10%
C2012X8R1C105K	0805	X8R	16	1,000,000	+/-10%
C3216X8R1H684K	1206	X8R	50	680,000	+/-10%
C3216X8R1H105K	1206	X8R	50	1,000,000	+/-10%
C3216X8R1E155K	1206	X8R	25	1,500,000	+/-10%
C3216X8R1E225K	1206	X8R	25	2,200,000	+/-10%
C3216X8R1C335K	1206	X8R	16	3,300,000	+/-10%
C3216X8R1C475K	1206	X8R	16	4,700,000	+/-10%
C3225X8R1C685K	1210	X8R	16	6,800,000	+/-10%
C3225X8R1C106K	1210	X8R	16	10,000,000	+/-10%
C1005C0G1H100D/EPOXY	0402	C0G	50	10	+/-0.50pF
C1005C0G1H101J/EPOXY	0402	C0G	50	100	+/-5%
C1608C0G1H100D/EPOXY	0603	C0G	50	10	+/-0.50pF
C1608C0G1H101J/EPOXY	0603	C0G	50	100	+/-5%
C1608C0G1H102J/EPOXY	0603	C0G	50	1,000	+/-5%
C1608C0G2A101J/EPOXY	0603	C0G	100	100	+/-5%
C1608C0G2A221J/EPOXY	0603	C0G	100	220	+/-5%
C1608C0G2A471J/EPOXY	0603	C0G	100	470	+/-5%
C1608C0G2A102J/EPOXY	0603	C0G	100	1,000	+/-5%
C1608X7R1H102K/EPOXY	0603	X7R	50	1,000	+/-10%
C1608X7R1H222K/EPOXY	0603	X7R	50	2,200	+/-10%
C1608X7R1H472K/EPOXY	0603	X7R	50	4,700	+/-10%
C1608X7R1H103K/EPOXY	0603	X7R	50	10,000	+/-10%
C1608X7R1H223K/EPOXY	0603	X7R	50	22,000	+/-10%
C1608X7R1H473K/EPOXY	0603	X7R	50	47,000	+/-10%
C1608X7R1H104K/EPOXY	0603	X7R	50	100,000	+/-10%
C2012X7R1E105K/EPOXY	0805	X7R	25	1,000,000	+/-10%
C3216X7R1E106M/EPOXY	1206	X7R	25	10,000,000	+/-20%
C3225X7R1H105K/EPOXY	1210	X7R	50	1,000,000	+/-10%
C1005X8R1H221K/EPOXY	0402	X8R	50	220	+/-10%
C1005X8R1H471K/EPOXY	0402	X8R	50	470	+/-10%
C1005X8R1H102K/EPOXY	0402	X8R	50	1,000	+/-10%
C1005X8R1H222K/EPOXY	0402	X8R	50	2,200	+/-10%
C1005X8R1H472K/EPOXY	0402	X8R	50	4,700	+/-10%
C1005X8R1E103K/EPOXY	0402	X8R	25	10,000	+/-10%
C1608X8R2A102K/EPOXY	0603	X8R	100	1,000	+/-10%
C1608X8R2A222K/EPOXY	0603	X8R	100	2,200	+/-10%
C1608X8R2A472K/EPOXY	0603	X8R	100	4,700	+/-10%
C1608X8R2A103K/EPOXY	0603	X8R	100	10,000	+/-10%

TDK Part Number (Ordering Code)	Case Size	T.C. Code	Voltage (DC)	Cap (pF)	Cap Tolerance
C1608X8R1H102K/EPOXY	0603	X8R	50	1,000	+/-10%
C1608X8R1H103K/EPOXY	0603	X8R	50	10,000	+/-10%
C1608X8R1H223K/EPOXY	0603	X8R	50	22,000	+/-10%
C1608X8R1H473K/EPOXY	0603	X8R	50	47,000	+/-10%
C1608X8R1E104K/EPOXY	0603	X8R	25	100,000	+/-10%
C2012X8R1H104K/EPOXY	0805	X8R	50	100,000	+/-10%
C3216X8R1E105K/EPOXY	1206	X8R	25	1,000,000	+/-10%

## SAN JOSE DISTRICT OFFICE

Serving USA - Northern CA, NV, WA, ID, OR, WY, UT, MT  
 Serving CANADA - BC, AB, YT, NT, SK, MB  
 1740 Technology Drive, Suite 510  
 San Jose, CA 95110  
 Phone: (408) 437-9585  
 Fax: (408) 437-9591  
 Contact: Chris Keller

## SAN DIEGO DISTRICT OFFICE

Serving USA - Southern CA  
 9350 Waxie Way, Suite 520  
 San Diego, CA 92122  
 Phone: (858) 715-4200  
 Fax: (858) 505-8725  
 Contact: Mitch Oda (in San Diego), Marc Picard (in L.A. office)

## NEW JERSEY DISTRICT OFFICE

Serving USA - WV, PA, NY, NJ, DC, MD, DE, VA  
 485-B Route 1 South, Suite 200  
 Iselin, NJ 8830  
 Phone: (908) 653-0910  
 Contact: Tony Pepe, John Gibson

## NEW ENGLAND DISTRICT OFFICE

Serving USA - CT, MA  
 Serving CANADA - NL, PE, NS, NB, QC, ON  
 264 S. River Road, Suite 416  
 Bedford, NH 3110  
 Phone: (603) 622-0003  
 Fax: (603) 622-1196  
 Contact: Alan Killen, John Gibson

## LOS ANGELES SALES OFFICE

Serving USA - Southern CA, AZ  
 11070 Valley View Street  
 Cypress, CA 90630  
 Phone: (714) 934-1212  
 Fax: (714) 897-5894  
 Contact: Mitch Oda (in San Diego), Marc Picard (in L.A. office)

## INDIANAPOLIS DISTRICT OFFICE

Serving USA - KY, IN, OH  
 4015 W. Vincennes Road  
 Indianapolis, IN 46268  
 Phone: (317) 872-0370  
 Fax: (317) 872-2978  
 Contact: Mike White

## HUNTSVILLE DISTRICT OFFICE

Serving USA - AL, TN, MS  
 4015 W. Vincennes Road  
 Indianapolis, IN 46268  
 Phone: (317) 872-0370  
 Fax: (317) 872-2978  
 Contact: Mike White

## GREENSBORO DISTRICT OFFICE

Serving USA - SC, NC, GA, FL, PR  
 200 Centerport Drive, Suite 325  
 Greensboro, NC 27409  
 Phone: (336) 292-0012  
 Fax: (336) 292-3831  
 Contact: John Gibson

- R&D centers
- Production centers
- R&D and production centers

## DETROIT DISTRICT OFFICE

Serving USA - MI  
 38701 Seven Mile Road, Suite 250  
 Livonia, MI 48152  
 Phone: (734) 462-1210  
 Fax: (734) 462-1193  
 Contact: Masa Yano

## DENVER SALES OFFICE

Serving USA - CO  
 357 S. McCaslin Blvd., Suite 200  
 Louisville, CO 80027  
 Phone: (408) 467-5211  
 Fax: (408) 437-9591  
 Contact: Chris Keller

## DALLAS DISTRICT OFFICE

Serving USA - AR, OK, NM, TX, AK, LA and MEXICO  
 511 E. Carpenter Freeway, Suite 690  
 Irving, TX 75062  
 Phone: (972) 506-9800  
 Fax: (972) 869-3353  
 Contact: Max Treptow

## CHICAGO DISTRICT OFFICE

Serving USA - ND, SD, IA, IL, WI, KS, MO, MN, NE  
 475 Half Day Road, Suite 300  
 Lincolnshire, IL 60056  
 Phone: (847) 699-2299  
 Fax: (847) 803-6296  
 Contact: Mike Tumminaro



**Americas**



# TDK Sales Representative Offices

South Bridge, LLC  
Georgia, USA  
[Email: bobbil@southbridge.net](mailto:bobbil@southbridge.net)  
[Website: www.southbridge.net](http://www.southbridge.net)

Quad State Sales and Marketing  
Texas, USA  
[Email: kbrayman@quadstatesales.com](mailto:kbrayman@quadstatesales.com)  
[Website: www.quadstatesales.com](http://www.quadstatesales.com)

Omega Electronic Sales, Inc.  
Eastern Pennsylvania, USA  
[Email: office@omegasales.com](mailto:office@omegasales.com)  
[Website: www.omegasales.com](http://www.omegasales.com)

Fusion Sourcing Group  
Northern New Jersey, USA  
[Email: TDKsales@fusionsourcing.com](mailto:TDKsales@fusionsourcing.com)  
[Website: www.fusionsourcing.com](http://www.fusionsourcing.com)

Pan American Technical Sales  
Mexico  
[Email: sales@panamsales.com](mailto:sales@panamsales.com)  
[Website: www.panamsales.com](http://www.panamsales.com)

South Bridge, LLC  
Mississippi, USA  
[Email: sherrill@southbridge.net](mailto:sherrill@southbridge.net)  
[Website: www.southbridge.net](http://www.southbridge.net)

Quad State Sales and Marketing  
Arkansas, USA  
[Email: kbrayman@quadstatesales.com](mailto:kbrayman@quadstatesales.com)  
[Website: www.quadstatesales.com](http://www.quadstatesales.com)

Mel Foster Company  
North Dakota, USA  
[Email: kristine@melfoster.com](mailto:kristine@melfoster.com)  
[Website: www.melfoster.com](http://www.melfoster.com)

Fusion Sourcing Group  
New York, USA  
[Email: TDKsales@fusionsourcing.com](mailto:TDKsales@fusionsourcing.com)  
[Website: www.fusionsourcing.com](http://www.fusionsourcing.com)

Davetek Marketing Inc  
Yukon Territory, Canada  
[Email: salesinfo@davetek.com](mailto:salesinfo@davetek.com)  
[Website: www.davetek.com](http://www.davetek.com)

South Bridge, LLC  
North Carolina, USA  
[Email: crystal@southbridge.net](mailto:crystal@southbridge.net)  
[Website: www.southbridge.net](http://www.southbridge.net)

Procyon Technical Sales  
New Mexico, USA  
[Email: lfisher@procyonsales.com](mailto:lfisher@procyonsales.com)  
[Website: www.procyonsales.com](http://www.procyonsales.com)

Mel Foster Company  
USA  
[Email: sonja@melfoster.com](mailto:sonja@melfoster.com)  
[Website: www.melfoster.com](http://www.melfoster.com)

Enco Marketing  
Michigan, USA  
[Email: Brett.kauffman@encomarketing.com](mailto:Brett.kauffman@encomarketing.com)  
[Website: www.encomarketing.com](http://www.encomarketing.com)

Davetek Marketing Inc  
Northwest Territory, Canada  
[Email: salesinfo@davetek.com](mailto:salesinfo@davetek.com)  
[Website: www.davetek.com](http://www.davetek.com)

South Bridge, LLC  
Florida, USA  
[Email: kim@southbridge.net](mailto:kim@southbridge.net)  
[Website: www.southbridge.net](http://www.southbridge.net)

Procyon Technical Sales  
Southern Nevada, USA  
[Email: lfisher@procyonsales.com](mailto:lfisher@procyonsales.com)  
[Website: www.procyonsales.com](http://www.procyonsales.com)

Mel Foster Company  
Minnesota, USA  
[Email: kristine@melfoster.com](mailto:kristine@melfoster.com)  
[Website: www.melfoster.com](http://www.melfoster.com)

Electro Reps Inc  
Ohio, USA  
[Email: eri@electro-reps.com](mailto:eri@electro-reps.com)  
[Website: www.electro-reps.com](http://www.electro-reps.com)

Davetek Marketing Inc  
Manitoba, Canada  
[Email: salesinfo@davetek.com](mailto:salesinfo@davetek.com)  
[Website: www.davetek.com](http://www.davetek.com)

South Bridge, LLC  
South Carolina, USA  
[Email: crystal@southbridge.net](mailto:crystal@southbridge.net)  
[Website: www.southbridge.net](http://www.southbridge.net)

Procyon Technical Sales  
Southern California, USA  
[Email: lfisher@procyonsales.com](mailto:lfisher@procyonsales.com)  
[Website: www.procyonsales.com](http://www.procyonsales.com)

Mel Foster Company  
South Dakota, USA  
[Email: kristine@melfoster.com](mailto:kristine@melfoster.com)  
[Website: www.melfoster.com](http://www.melfoster.com)

Electro Reps Inc  
Western Pennsylvania, USA  
[Email: eri@electro-reps.com](mailto:eri@electro-reps.com)  
[Website: www.electro-reps.com](http://www.electro-reps.com)

Davetek Marketing Inc  
Saskatchewan, Canada  
[Email: salesinfo@davetek.com](mailto:salesinfo@davetek.com)  
[Website: www.davetek.com](http://www.davetek.com)

South Bridge, LLC  
Western Tennessee, USA  
[Email: sherrill@southbridge.net](mailto:sherrill@southbridge.net)  
[Website: www.southbridge.net](http://www.southbridge.net)

Procyon Technical Sales  
Arizona, USA  
[Email: lfisher@procyonsales.com](mailto:lfisher@procyonsales.com)  
[Website: www.procyonsales.com](http://www.procyonsales.com)

Mel Foster Company  
Northwest Wisconsin, USA  
[Email: kristine@melfoster.com](mailto:kristine@melfoster.com)  
[Website: www.melfoster.com](http://www.melfoster.com)

Electro Reps Inc  
Kentucky, USA  
[Email: eri@electro-reps.com](mailto:eri@electro-reps.com)  
[Website: www.electro-reps.com](http://www.electro-reps.com)

Davetek Marketing Inc  
Alberta, Canada  
[Email: salesinfo@davetek.com](mailto:salesinfo@davetek.com)  
[Website: www.davetek.com](http://www.davetek.com)

South Bridge, LLC  
Eastern Tennessee, USA  
[Email: bobbil@southbridge.net](mailto:bobbil@southbridge.net)  
[Website: www.southbridge.net](http://www.southbridge.net)

Paragon Electronic Systems  
Vermont, USA  
[Email: sales@paragonelect.com](mailto:sales@paragonelect.com)  
[Website: www.paragonelect.com](http://www.paragonelect.com)

Luscombe Engineering Company  
Northern California, USA  
[Email: dbrown@lecsf.com](mailto:dbrown@lecsf.com)  
[Website: www.lecsf.com](http://www.lecsf.com)

Electro Reps Inc  
Indiana, USA  
[Email: eri@electro-reps.com](mailto:eri@electro-reps.com)  
[Website: www.electro-reps.com](http://www.electro-reps.com)

Davetek Marketing Inc  
British Columbia, Canada  
[Email: salesinfo@davetek.com](mailto:salesinfo@davetek.com)  
[Website: www.davetek.com](http://www.davetek.com)

South Bridge, LLC  
Alabama, USA  
[Email: sherrill@southbridge.net](mailto:sherrill@southbridge.net)  
[Website: www.southbridge.net](http://www.southbridge.net)

Paragon Electronic Systems  
Rhode Island, USA  
[Email: sales@paragonelect.com](mailto:sales@paragonelect.com)  
[Website: www.paragonelect.com](http://www.paragonelect.com)

Luscombe Engineering Company  
Northern Nevada, All products, USA  
[Email: dbrown@lecsf.com](mailto:dbrown@lecsf.com)  
[Website: www.lecsf.com](http://www.lecsf.com)

Electro Reps Inc  
West Virginia, USA  
[Email: eri@electro-reps.com](mailto:eri@electro-reps.com)  
[Website: www.electro-reps.com](http://www.electro-reps.com)

Cee-Jay Micro LTD  
Prince Edward Island, Canada  
[Email: hendrik@cjmicro.com](mailto:hendrik@cjmicro.com)  
[Website: www.cjmicro.com](http://www.cjmicro.com)

Seltec Sales Corporation  
Southern Illinois, USA  
[Email: christy\\_meyer@seltec-sales.com](mailto:christy_meyer@seltec-sales.com)  
[Website: www.seltecsales.com](http://www.seltecsales.com)

Paragon Electronic Systems  
New Hampshire, USA  
[Email: sales@paragonelect.com](mailto:sales@paragonelect.com)  
[Website: www.paragonelect.com](http://www.paragonelect.com)

Innovatech Rocky Mountains  
Montana, USA  
[Email: ggoodenow@innovatechrm.com](mailto:ggoodenow@innovatechrm.com)  
[Website: www.innovatechrm.com](http://www.innovatechrm.com)

ELCOM  
Washington, D.C., USA  
[Email: ESC@elcomsales.com](mailto:ESC@elcomsales.com)  
[Website: www.elcomsales.com](http://www.elcomsales.com)

Cee-Jay Micro LTD  
Nova Scotia, Canada  
[Email: hendrik@cjmicro.com](mailto:hendrik@cjmicro.com)  
[Website: www.cjmicro.com](http://www.cjmicro.com)

Seltec Sales Corporation  
Kansas, USA  
[Email: brian.young@seltec-sales.com](mailto:brian.young@seltec-sales.com)  
[Website: www.seltecsales.com](http://www.seltecsales.com)

Paragon Electronic Systems  
Maine, USA  
[Email: sales@paragonelect.com](mailto:sales@paragonelect.com)  
[Website: www.paragonelect.com](http://www.paragonelect.com)

Innovatech Rocky Mountains  
Colorado, USA  
[Email: ggoodenow@innovatechrm.com](mailto:ggoodenow@innovatechrm.com)  
[Website: www.innovatechrm.com](http://www.innovatechrm.com)

ELCOM  
Virginia, USA  
[Email: ESC@elcomsales.com](mailto:ESC@elcomsales.com)  
[Website: www.elcomsales.com](http://www.elcomsales.com)

Cee-Jay Micro LTD  
New Brunswick, Canada  
[Email: hendrik@cjmicro.com](mailto:hendrik@cjmicro.com)  
[Website: www.cjmicro.com](http://www.cjmicro.com)

Seltec Sales Corporation  
Missouri, USA  
[Email: christy\\_meyer@seltec-sales.com](mailto:christy_meyer@seltec-sales.com)  
[Website: www.seltecsales.com](http://www.seltecsales.com)

Paragon Electronic Systems  
Massachusetts, USA  
[Email: sales@paragonelect.com](mailto:sales@paragonelect.com)  
[Website: www.paragonelect.com](http://www.paragonelect.com)

Innovatech Rocky Mountains  
Wyoming, USA  
[Email: ggoodenow@innovatechrm.com](mailto:ggoodenow@innovatechrm.com)  
[Website: www.innovatechrm.com](http://www.innovatechrm.com)

ELCOM  
Maryland, USA  
[Email: ESC@elcomsales.com](mailto:ESC@elcomsales.com)  
[Website: www.elcomsales.com](http://www.elcomsales.com)

Cee-Jay Micro LTD  
Quebec, Canada  
[Email: hendrik@cjmicro.com](mailto:hendrik@cjmicro.com)  
[Website: www.cjmicro.com](http://www.cjmicro.com)

Seltec Sales Corporation  
Nebraska, USA  
[Email: brian.young@seltec-sales.com](mailto:brian.young@seltec-sales.com)  
[Website: www.seltecsales.com](http://www.seltecsales.com)

Paragon Electronic Systems  
Connecticut, USA  
[Email: sales@paragonelect.com](mailto:sales@paragonelect.com)  
[Website: www.paragonelect.com](http://www.paragonelect.com)

Innovatech Rocky Mountains  
Utah, USA  
[Email: ggoodenow@innovatechrm.com](mailto:ggoodenow@innovatechrm.com)  
[Website: www.innovatechrm.com](http://www.innovatechrm.com)

Earl & Brown Co., Inc.  
Oregon, USA  
[Email: ichinn@earlbrownrep.com](mailto:ichinn@earlbrownrep.com)  
[Website: www.earlbrownrep.com](http://www.earlbrownrep.com)

Cee-Jay Micro LTD  
Ontario, Canada  
[Email: hendrik@cjmicro.com](mailto:hendrik@cjmicro.com)  
[Website: www.cjmicro.com](http://www.cjmicro.com)

Quad State Sales and Marketing  
Oklahoma, USA  
[Email: kbrayman@quadstatesales.com](mailto:kbrayman@quadstatesales.com)  
[Website: www.quadstatesales.com](http://www.quadstatesales.com)

Omega Electronic Sales, Inc.  
Southern New Jersey, USA  
[Email: office@omegasales.com](mailto:office@omegasales.com)  
[Website: www.omegasales.com](http://www.omegasales.com)

HLC Ltd  
Northern Illinois, USA  
[Email: djohnson@hlcltd.com](mailto:djohnson@hlcltd.com)  
[Website: www.hlcltd.com](http://www.hlcltd.com)

Earl & Brown Co., Inc.  
Idaho, USA  
[Email: dpoulos@earlbrownrep.com](mailto:dpoulos@earlbrownrep.com)  
[Website: www.earlbrownrep.com](http://www.earlbrownrep.com)

South Bridge, LLC  
Puerto Rico, Puerto Rico  
[Email: fabian@southbridge.net](mailto:fabian@southbridge.net)  
[Website: www.southbridge.net](http://www.southbridge.net)

Quad State Sales and Marketing  
Louisiana, USA  
[Email: kbrayman@quadstatesales.com](mailto:kbrayman@quadstatesales.com)  
[Website: www.quadstatesales.com](http://www.quadstatesales.com)

Omega Electronic Sales, Inc.  
Delaware, USA  
[Email: office@omegasales.com](mailto:office@omegasales.com)  
[Website: www.omegasales.com](http://www.omegasales.com)

HLC Ltd  
Southeast Wisconsin, USA  
[Email: djohnson@hlcltd.com](mailto:djohnson@hlcltd.com)  
[Website: www.hlcltd.com](http://www.hlcltd.com)

Earl & Brown Co., Inc.  
Washington, USA  
[Email: dpoulos@earlbrownrep.com](mailto:dpoulos@earlbrownrep.com)  
[Website: www.earlbrownrep.com](http://www.earlbrownrep.com)



Power by creativity

Attach Business Card Here

## HELPFUL LINKS

---

- ❖ Main Web Page: [www.tdk.com](http://www.tdk.com)
  - ❖ Product Search: [www.tdk.com/s\\_char.php](http://www.tdk.com/s_char.php)
  - ❖ Technical Support Tools: [www.tdk.com/tst.php](http://www.tdk.com/tst.php)
  - ❖ FAQs Page: [www.tdk.com/tst\\_faq.php](http://www.tdk.com/tst_faq.php)
  - ❖ Capacitor Technical Notes: [www.tdk.com/cap\\_technotes.php](http://www.tdk.com/cap_technotes.php)
- 

### **TDK Corporation of America**

475 Half Day Road, Suite 300  
Lincolnshire, IL 60069