

SMPS MOSFET

IRF7478PbF

HEXFET® Power MOSFET

Applications

- High frequency DC-DC converters
- Lead-Free

V_{DSS}	$R_{DS(on)}$ max (m Ω)	I_D
60V	26 @ $V_{GS} = 10V$	4.2A
	30 @ $V_{GS} = 4.5V$	3.5A

Benefits

- Low Gate to Drain Charge to Reduce Switching Losses
- Fully Characterized Capacitance Including Effective C_{OSS} to Simplify Design, (See App. Note AN1001)
- Fully Characterized Avalanche Voltage and Current

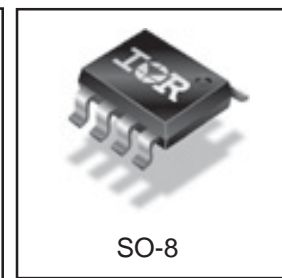
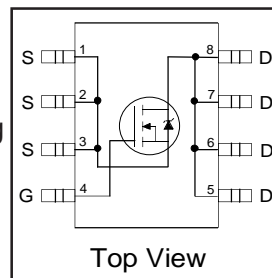

Absolute Maximum Ratings

	Parameter	Max.	Units
I_D @ $T_A = 25^\circ C$	Continuous Drain Current, V_{GS} @ 10V	7.0	A
I_D @ $T_A = 70^\circ C$	Continuous Drain Current, V_{GS} @ 10V	5.6	
I_{DM}	Pulsed Drain Current ①	56	
P_D @ $T_A = 25^\circ C$	Power Dissipation ②	2.5	W
	Linear Derating Factor	0.02	W/ $^\circ C$
V_{GS}	Gate-to-Source Voltage	± 20	V
dv/dt	Peak Diode Recovery dv/dt ③	3.7	V/ns
T_J	Operating Junction and	-55 to + 150	$^\circ C$
T_{STG}	Storage Temperature Range		
	Soldering Temperature, for 10 seconds	300 (1.6mm from case)	

Thermal Resistance

Symbol	Parameter	Typ.	Max.	Units
$R_{\theta JL}$	Junction-to-Drain Lead	—	20	$^\circ C/W$
$R_{\theta JA}$	Junction-to-Ambient ④	—	50	

Notes ① through ⑥ are on page 8
www.irf.com

IRF7478PbF

International
IR Rectifier

Static @ $T_J = 25^\circ\text{C}$ (unless otherwise specified)

	Parameter	Min.	Typ.	Max.	Units	Conditions
$V_{(BR)DSS}$	Drain-to-Source Breakdown Voltage	60	—	—	V	$V_{GS} = 0V, I_D = 250\mu A$
$\Delta V_{(BR)DSS}/\Delta T_J$	Breakdown Voltage Temp. Coefficient	—	0.065	—	V/°C	Reference to $25^\circ\text{C}, I_D = 1\text{mA}$
$R_{DS(on)}$	Static Drain-to-Source On-Resistance	—	20	26	m Ω	$V_{GS} = 10V, I_D = 4.2A$ ③
		—	23	30		$V_{GS} = 4.5V, I_D = 3.5A$ ③
$V_{GS(th)}$	Gate Threshold Voltage	1.0	—	3.0	V	$V_{DS} = V_{GS}, I_D = 250\mu A$
I_{DSS}	Drain-to-Source Leakage Current	—	—	20	μA	$V_{DS} = 48V, V_{GS} = 0V$
		—	—	100		$V_{DS} = 48V, V_{GS} = 0V, T_J = 125^\circ\text{C}$
I_{GSS}	Gate-to-Source Forward Leakage	—	—	100	nA	$V_{GS} = 20V$
	Gate-to-Source Reverse Leakage	—	—	-100		$V_{GS} = -20V$

Dynamic @ $T_J = 25^\circ\text{C}$ (unless otherwise specified)

	Parameter	Min.	Typ.	Max.	Units	Conditions
g_{fs}	Forward Transconductance	17	—	—	S	$V_{DS} = 50V, I_D = 4.2A$
Q_g	Total Gate Charge	—	21	31	nC	$I_D = 4.2A$
Q_{gs}	Gate-to-Source Charge	—	4.3	—		$V_{DS} = 48V$
Q_{gd}	Gate-to-Drain ("Miller") Charge	—	9.6	—		$V_{GS} = 4.5V$
$t_{d(on)}$	Turn-On Delay Time	—	7.7	—	ns	$V_{DD} = 30V$
t_r	Rise Time	—	2.6	—		$I_D = 4.2A$
$t_{d(off)}$	Turn-Off Delay Time	—	44	—		$R_G = 6.2\Omega$
t_f	Fall Time	—	13	—		$V_{GS} = 10V$ ③
C_{iss}	Input Capacitance	—	1740	—		$V_{GS} = 0V$
C_{oss}	Output Capacitance	—	300	—	pF	$V_{DS} = 25V$
C_{rss}	Reverse Transfer Capacitance	—	37	—		$f = 1.0\text{MHz}$
C_{oss}	Output Capacitance	—	1590	—		$V_{GS} = 0V, V_{DS} = 1.0V, f = 1.0\text{MHz}$
C_{oss}	Output Capacitance	—	220	—		$V_{GS} = 0V, V_{DS} = 48V, f = 1.0\text{MHz}$
$C_{oss \text{ eff.}}$	Effective Output Capacitance	—	410	—		$V_{GS} = 0V, V_{DS} = 0V \text{ to } 48V$ ⑤

Symbol	Parameter	Typ.	Max.	Units
E_{AS}	Single Pulse Avalanche Energy②	—	140	mJ
I_{AR}	Avalanche Current①	—	4.2	A

Diode Characteristics

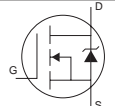
	Parameter	Min.	Typ.	Max.	Units	Conditions
I_S	Continuous Source Current (Body Diode)	—	—	2.3	A	MOSFET symbol showing the integral reverse p-n junction diode. 
I_{SM}	Pulsed Source Current (Body Diode) ①	—	—	56		
V_{SD}	Diode Forward Voltage	—	—	1.3	V	$T_J = 25^\circ\text{C}, I_S = 4.2A, V_{GS} = 0V$ ③
t_{rr}	Reverse Recovery Time	—	52	78	ns	$T_J = 25^\circ\text{C}, I_F = 4.2A$
Q_{rr}	Reverse Recovery Charge	—	100	150	nC	$di/dt = 100A/\mu s$ ③

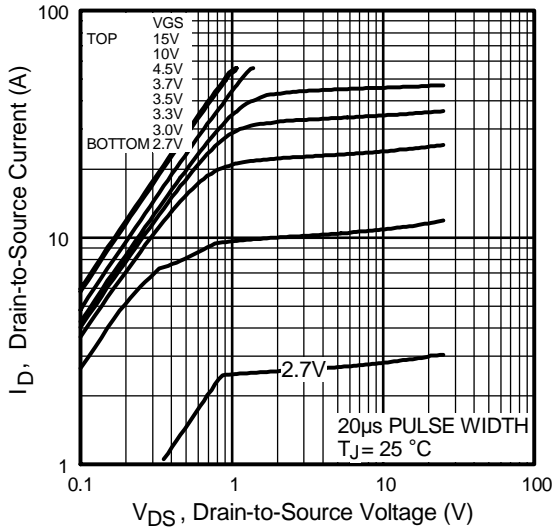

Fig 1. Typical Output Characteristics

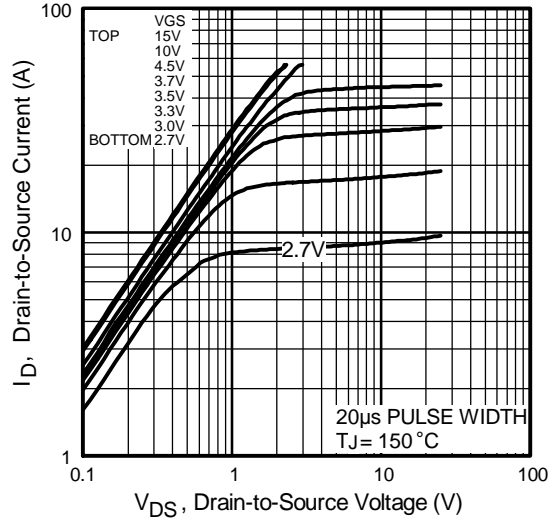

Fig 2. Typical Output Characteristics

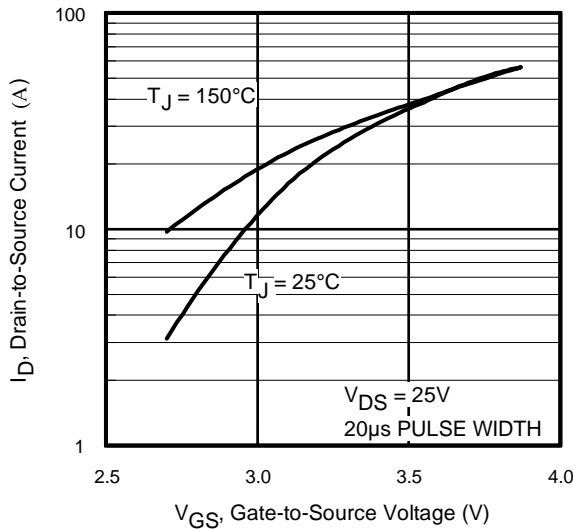

Fig 3. Typical Transfer Characteristics

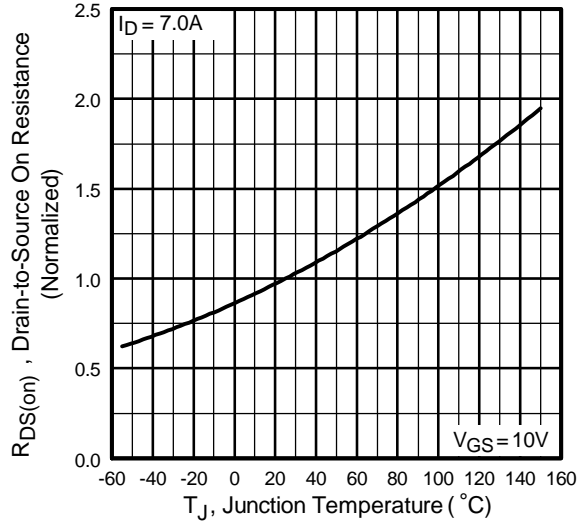

Fig 4. Normalized On-Resistance Vs. Temperature

IRF7478PbF

International
IR Rectifier

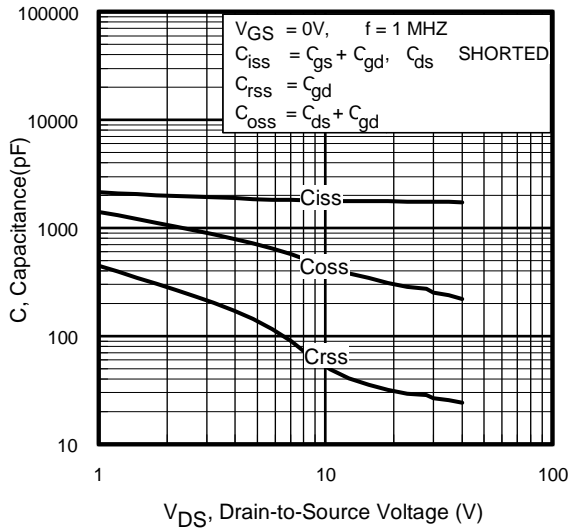

Fig 5. Typical Capacitance Vs. Drain-to-Source Voltage

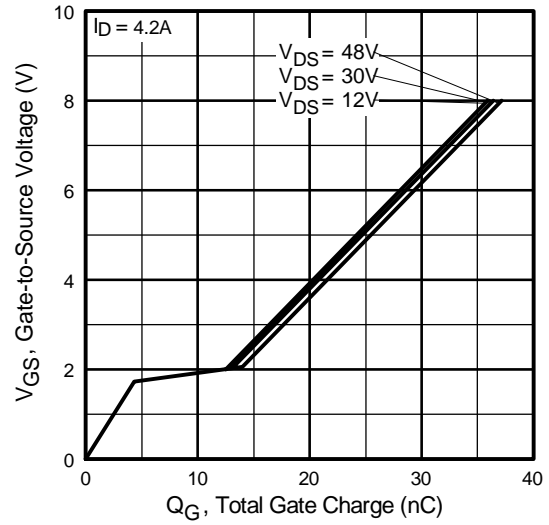

Fig 6. Typical Gate Charge Vs. Gate-to-Source Voltage

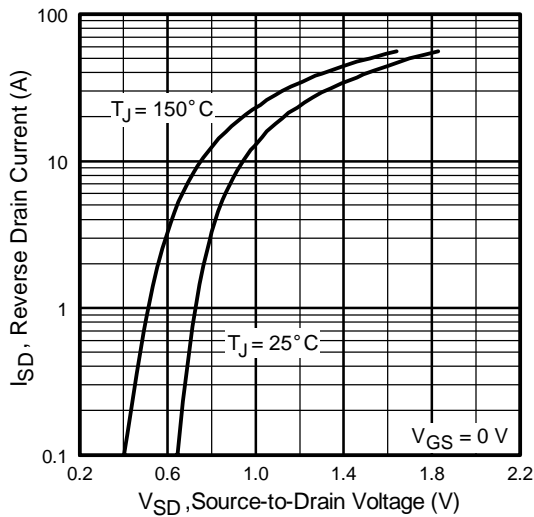

Fig 7. Typical Source-Drain Diode Forward Voltage

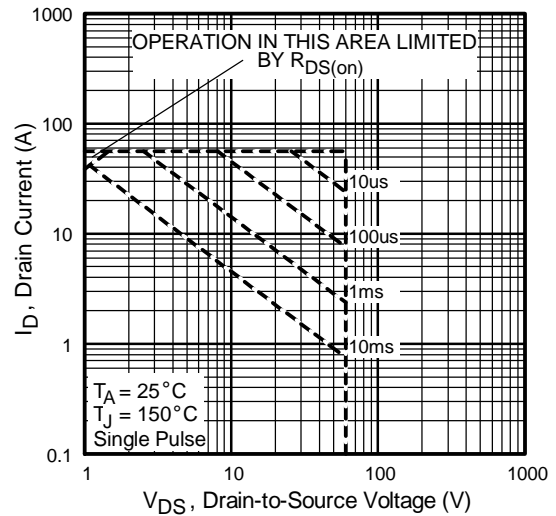

Fig 8. Maximum Safe Operating Area

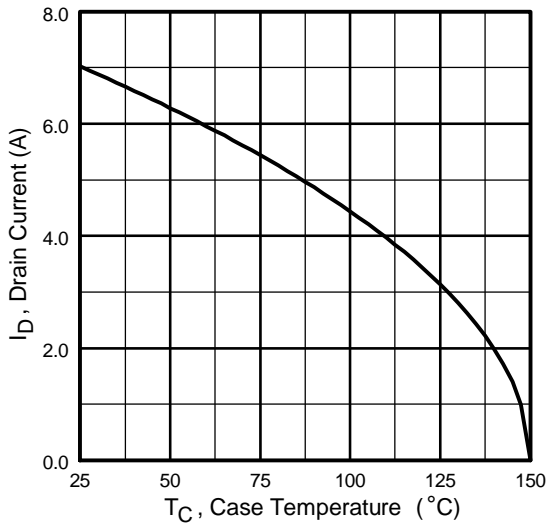

Fig 9. Maximum Drain Current Vs. Ambient Temperature



Fig 10a. Switching Time Test Circuit

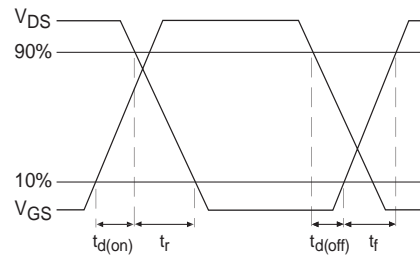

Fig 10b. Switching Time Waveforms

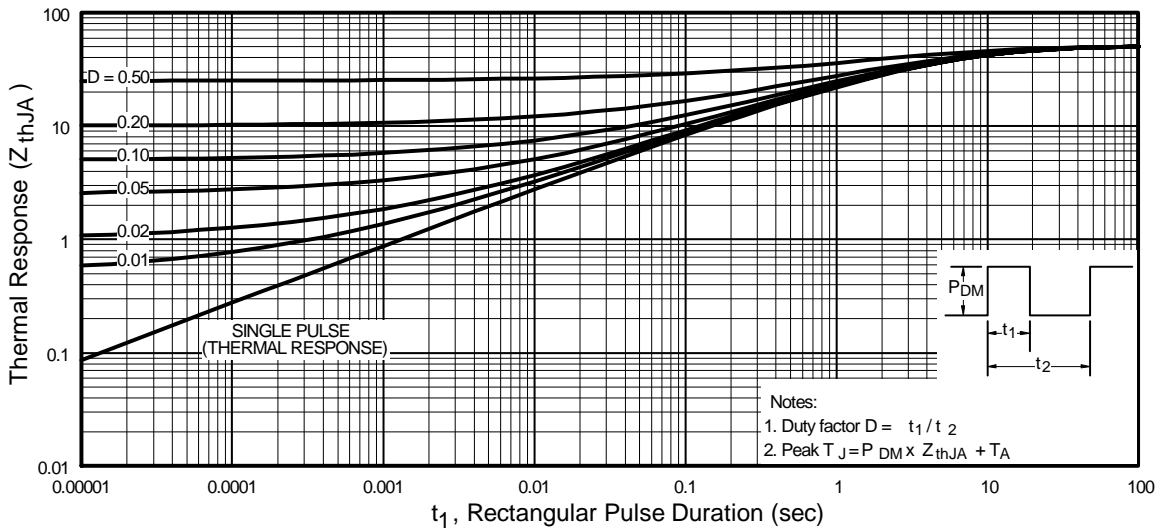

Fig 11. Maximum Effective Transient Thermal Impedance, Junction-to-Ambient

IRF7478PbF

International
IR Rectifier

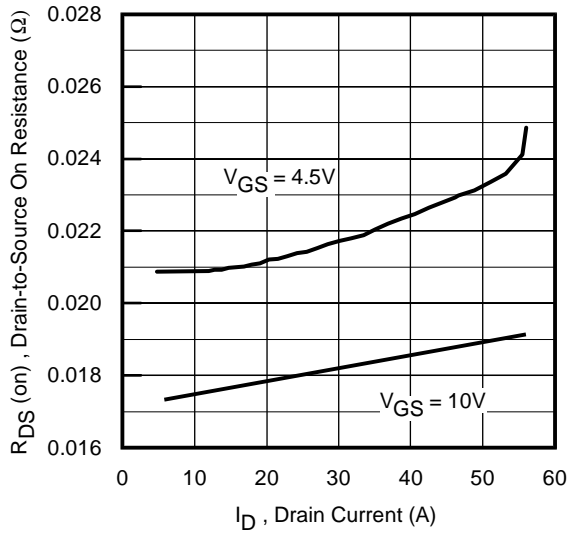

Fig 12. On-Resistance Vs. Drain Current

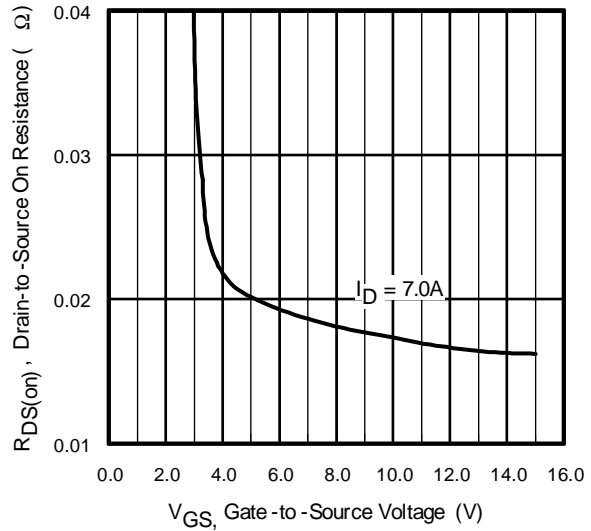

Fig 13. On-Resistance Vs. Gate Voltage



Fig 14a&b. Basic Gate Charge Test Circuit and Waveform

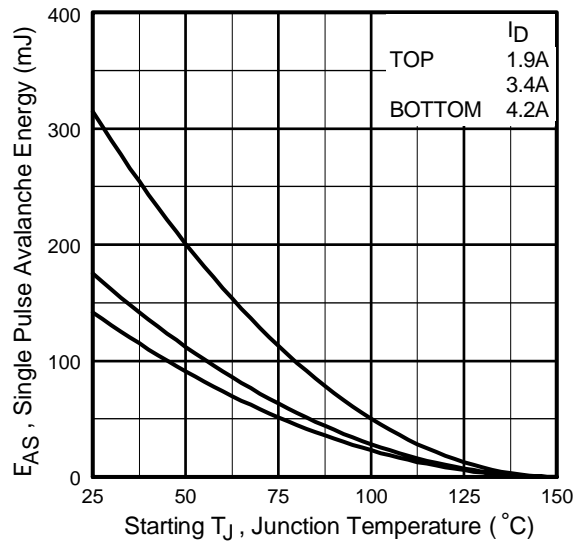

Fig 15c. Maximum Avalanche Energy Vs. Drain Current

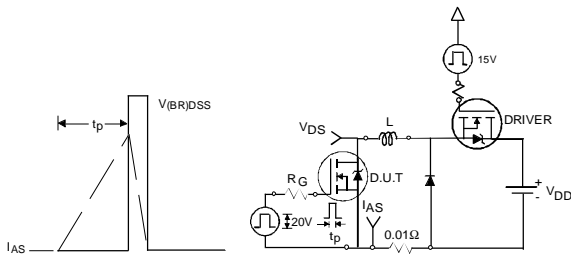
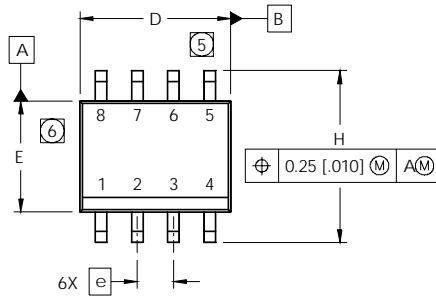

Fig 15a&b. Unclamped Inductive Test circuit and Waveforms

SO-8 Package Outline

Dimensions are shown in millimeters (inches)



DIM	INCHES		MILLIMETERS	
	MIN	MAX	MIN	MAX
A	.0532	.0688	1.35	1.75
A1	.0040	.0098	0.10	0.25
b	.013	.020	0.33	0.51
c	.0075	.0098	0.19	0.25
D	.189	.1968	4.80	5.00
E	.1497	.1574	3.80	4.00
e	.050 BASIC		1.27 BASIC	
e1	.025 BASIC		0.635 BASIC	
H	.2284	.2440	5.80	6.20
K	.0099	.0196	0.25	0.50
L	.016	.050	0.40	1.27
y	0°	8°	0°	8°

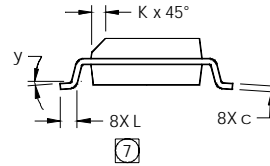
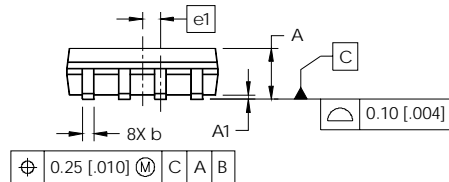

NOTES:

1. DIMENSIONING & TOLERANCING PER ASME Y14.5M-1994.
2. CONTROLLING DIMENSION: MILLIMETER
3. DIMENSIONS ARE SHOWN IN MILLIMETERS [INCHES].
4. OUTLINE CONFORMS TO JEDEC OUTLINE MS-012AA
- ⑤ DIMENSION DOES NOT INCLUDE MOLD PROTRUSIONS. MOLD PROTRUSIONS NOT TO EXCEED 0.15 [0.006].
- ⑥ DIMENSION DOES NOT INCLUDE MOLD PROTRUSIONS. MOLD PROTRUSIONS NOT TO EXCEED 0.25 [0.010].
- ⑦ DIMENSION IS THE LENGTH OF LEAD FOR SOLDERING TO A SUBSTRATE.

FOOTPRINT

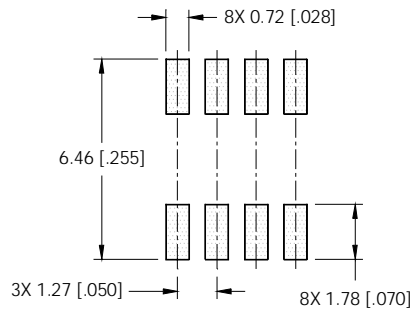

SO-8 Part Marking

EXAMPLE: THIS IS AN IRF7101 (MOSFET)

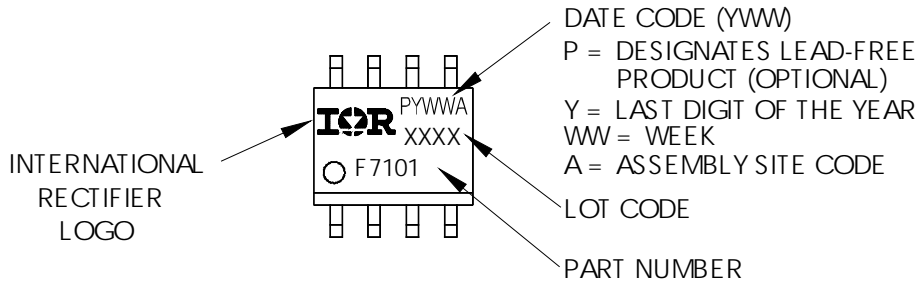

IRF7478PbF

SO-8 Tape and Reel

Dimensions are shown in millimeters (inches)

International
IR Rectifier

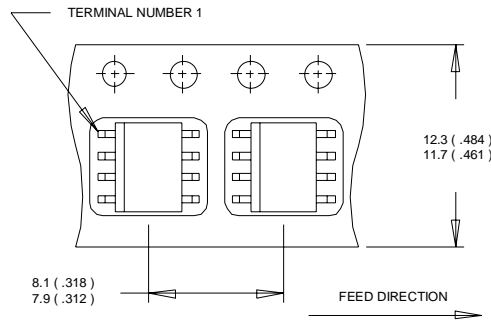

- NOTES:
1. CONTROLLING DIMENSION : MILLIMETER.
 2. ALL DIMENSIONS ARE SHOWN IN MILLIMETERS(INCHES).
 3. OUTLINE CONFORMS TO EIA-481 & EIA-541.

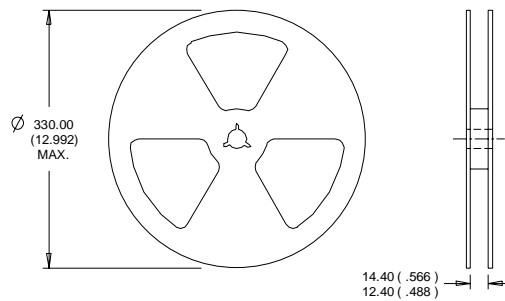

- NOTES :
1. CONTROLLING DIMENSION : MILLIMETER.
 2. OUTLINE CONFORMS TO EIA-481 & EIA-541.

Notes:

- ① Repetitive rating; pulse width limited by max. junction temperature.
- ② Starting $T_J = 25^\circ\text{C}$, $L = 16\text{mH}$
 $R_G = 25\Omega$, $I_{AS} = 4.2\text{A}$.
- ③ Pulse width $\leq 400\mu\text{s}$; duty cycle $\leq 2\%$.
- ④ When mounted on 1 inch square copper board
- ⑤ C_{OSS} eff. is a fixed capacitance that gives the same charging time as C_{OSS} while V_{DS} is rising from 0 to 80% V_{DSS}
- ⑥ $I_{SD} \leq 4.2\text{A}$, $di/dt \leq 160\text{A}/\mu\text{s}$, $V_{DD} \leq V_{(BR)DSS}$,
 $T_J \leq 150^\circ\text{C}$

Data and specifications subject to change without notice.
This product has been designed and qualified for the Consumer market.
Qualifications Standards can be found on IR's Web site.

International
IR Rectifier

IR WORLD HEADQUARTERS: 233 Kansas St., El Segundo, California 90245, USA Tel: (310) 252-7105
TAC Fax: (310) 252-7903

Visit us at www.irf.com for sales contact information.09/04

www.irf.com

IMPORTANT NOTICE

The information given in this document shall in no event be regarded as a guarantee of conditions or characteristics ("Beschaffheitsgarantie").

With respect to any examples, hints or any typical values stated herein and/or any information regarding the application of the product, Infineon Technologies hereby disclaims any and all warranties and liabilities of any kind, including without limitation warranties of non-infringement of intellectual property rights of any third party.

In addition, any information given in this document is subject to customer's compliance with its obligations stated in this document and any applicable legal requirements, norms and standards concerning customer's products and any use of the product of Infineon Technologies in customer's applications.

The data contained in this document is exclusively intended for technically trained staff. It is the responsibility of customer's technical departments to evaluate the suitability of the product for the intended application and the completeness of the product information given in this document with respect to such application.

For further information on the product, technology, delivery terms and conditions and prices please contact your nearest Infineon Technologies office (www.infineon.com).

WARNINGS

Due to technical requirements products may contain dangerous substances. For information on the types in question please contact your nearest Infineon Technologies office.

Except as otherwise explicitly approved by Infineon Technologies in a written document signed by authorized representatives of Infineon Technologies, Infineon Technologies' products may not be used in any applications where a failure of the product or any consequences of the use thereof can reasonably be expected to result in personal injury.